



European Color Initiative
www.eci.org

ECI-Guidelines

**Guidelines for device-independent color data processing
in accordance with the ICC-Standard**

Advertisement production, catalogue production,
general offset production, editorial and publishing techniques

ECI, 14.11.1999, Version 1.1 (English translation, 05.2000)

Contents

Foreword

1. Objectives of the »European Color Initiative«
 2. Objectives and Contents of the ECI-Guidelines
 3. Commitment to Supporting the ICC-Standard
 4. Establishing the Proof
 - 4.1 »Idealized ICC-Proof«
 - 4.2 »ICC-Proof« (»ICC Contract Proof«)
 - 4.3 »ICC-Proof with Generic Profiles« (»ICC Contract Proof«)
 - 4.4 »ICC-Soft Proof«
 - 4.5 Proprietary Digital Proof Methods
 5. Administrative Communication between »Data Supplier« and »Data Receiver«
 6. Basic Workflow for Digital Processing of Printed Material
 7. Technical Specifications for the Exchange of Advertisement Files
 - 7.1 Exchange Format
 - 7.2 Exchange Color Spaces
 - 7.3 Overprinting and Trapping
 - 7.4 Process and Data Control
 - 7.5 Proofs
 - 7.6 Data Exchange Media
 8. Technical Specifications for the Exchange of Files for Catalogue Production
 - 8.1 to 8.x
 9. Technical Specifications...
 - 9.1 to 9.x
- Appendix 1: Recommendations for the Adaptaion of ICC-Workflows in Advertising Production
- Appendix 2: Recommendations for the Adaptation of ICC-Workflows in Catalogue Production
- Appendix 3: Recommendations for the Adaptation of ICC-Workflows in General Offset Production
- Appendix 4: Recommendations for the Adaptation of ICC-Workflows in Editorial and Publishing Techniques
- Appendix 5: Process Control –The Ugra/FOGRA Media Wedge–
- Appendix 6: »MediaStandardPrint« (not included)
- Appendix 7: The Corner Points of the ICC-Standard
- Appendix 8: »The 10 Commandments of Color Managements«
- Appendix 9: Example of a Measuring File in Accordance with the Color Chart ISO 12642 (IT8.7-3)

Note: Grey chapters are in planning

Foreword

Digital color data processing in the communication industry has changed. The idea of reproducing color stipulatory and maintaining predictable and constant color information in all stages of processing is not new but technological changes call for new methods to put this into practice.

In traditional closed production cycles, color information, from beginning to end, was edited purely according to the process and device-dependently. Modern production environments however, are characterised by open, modular, fully-digital system environments. Increasing exchange of data, multiple usage of color data and unpredictable means of production make device-independent concepts of colour processing necessary. Put another way: Fully-digital system environments allow for new, efficient methods of working with color information.

In classical, CMYK-based reproduction technology, process-inherent alterations to color information were compensated for with the mutual balancing (linearization, calibration, exchange of characteristics) of peripherals and stages of process. As a rule, brightness and dot coverage information alone, such as gradation curves, copier and printing characteristics, were transported through the proprietary production process. (»densitometric-based color communication«). This method required that all the systems involved worked with the same primary color system (CMYK) and that the means of production, above all the target output medium with its characteristics of color reproduction (e.g. a particular printing process, a particular type of paper) were already known when digitizing artwork.

Densitometric-based color communication does not work in modern production environments consisting of system components with different primary color systems. For this reason a new strategy for color processing was developed known as »Color Management«. All input and output systems or partial processes involved in the production process are characterized in relation to a device-independent colorimetric reference system. These colorimetric device and process descriptions are saved as so-called »color-profiles«. Color information of an image, when being digitized or finished for a particular output medium, can be converted with individual color-profiles to the process components' different primary color systems.

In 1993 the »International Color Consortium« established a standard for a universal, platform-independent structure for such color-profiles. At the same time it commissioned the development of a »Color-Management-Framework« to allow for color transformations centrally in the operating system according to the ICC-standard and to be accessible for all hardware and software developers. In this way it is possible to exchange ICC-color profiles, to carry out any process-specific color adjustment on any platform at any time in the reproduction workflow and to exchange color data with a consistent definite colorimetric reference (i.e. the appropriate color-profile). Alongside the main objective to »organize« color even in open system environments, workflows can be automated with ICC-technology, labour can be optimized, costs reduced, technical color processing improved and thereby the quality of color reproduction increased.

For the user this change in color data processing means a reorganization of his reproduction workflows. Process-specific CMYK-data, due to their comparable small color range as archive color space, are not suitable for processing in variable production systems or the multiple use of data for different output media. Color data nowadays must be saved and processed device-independently. These guidelines were drawn up by the »European Color Initiative« (ECI) and deal with the introduction of efficient ICC-workflows in reproduction technology based on the ICC-standard.

1. Objectives of the »European Color Initiative«

The »European Color Initiative« (ECI) was founded in 1996, it is an amalgamation of international agencies, creative and technical pre-press businesses, printing houses, publishers and research institutes, (<http://www.eci.org>). The most important objective of the ECI is to promote the exchange of device-independently processed color data and to introduce efficient color management workflows based on the ICC-standard into advertisement production, editorial and publishing techniques, catalogue production and general offset production. To realize this objective, the following have been undertaken:

- The establishment of suitable data formats for the exchange of (print)data, prepared according to the ICC-convention.
- The harmonization of data exchange formats in respect of their ICC-compatibility and their suitability for saving device-independent color data.
- Formulation of request catalogues to hardware and software developers in the publishing industry.
- Formulation of request catalogues to technical standardization groups, e.g. the ICC.
- Drawing up of the »ECI-Guidelines« for promoting the introduction of ICC-workflows in the industry.
- Measures for training in businesses according to the ECI-Guidelines.
- The elaboration of a certification system for businesses that work according to the ECI-Guidelines.
- Publication of a list (»Yellow Page«) of all certified businesses.

2. Objectives and Contents of the ECI-Guidelines

This document should help the »user« to set up productive ICC-workflows, to automate device-independent color processing and to organize safely the exchange of ICC-capable color data. The contents divide into two blocks:

The first block (in Sections 7 to x) establishes »Technical Specifications for the Exchange of Color Data« between pre-press and the printing house. The specifications (data format, color space etc) are (first of all) defined differently for the main production areas »advertisement production«, »catalogue production«, »editorial and publishing techniques« and »general offset production«. They should ensure that the data can be further processed by the receiver without problem in ICC-based workflows.

In the second block, recommendations for the adaptation of ICC-workflows are given in the appendix. These recommendations are, among other things, orientated around the latest available hardware and software and their functions. This block has the objective to show the »beginner« how ICC-color management can be realized today in the main production areas mentioned.

These guidelines do not have the primary objective to stipulate the job data sent between »data supplier« and »data receiver« (e.g. with regard to format, print volume, color rendition etc.). The only exception is the ICC-information for exchange data and proofs. In order to ensure the viability of all persons and processes involved in the ICC-workflow, recommendations are made as to which ICC-information (utilised profiles etc.) should be passed on to the data receiver.

In 1997 the »Bundesverband Druck« (Federal Association of Printers) published »Media-Standard Print«. While the media-standard describes different modular components and modules such as data format, color spaces, profiles, process control, measuring techniques and standards, and »...these are to be used autonomously and properly by the user...«, the ECI-Guidelines establish technical specifications for the exchange of color data (data format, color space etc.) and aid the setting up of ICC-workflows for device-independent color processing. The measures described in »Media-Standard Print« for process control should be used for digital workflows in accordance with the ECI-Guidelines.

3. Commitment to Supporting the ICC-Standard

The members of the »European Color Initiative« (and the businesses certified in accordance with the ECI-Guidelines) commit themselves to the total support of the ICC-standard. This means, above all, the production and use of color profiles containing entries on the basis of the Default-Data-Area (»Required Tags«, »Optional Tags«), which are defined in the ICC-specifications. Manufacturer-specific »Private Tags«, not defined by the ICC, should not be supported. Analogous to this, only fully ICC-compatible CMMs (Color Matching Module) should be used that can process all entries without problem in the default-sector of the ICC-profiles.

The CMM influences the color transformation. The CMMs available on the market produce different results for color matching, due to varying curves in the conversion process or interpolation. The ECI recommends the use of »ColorSync 3.x« with the Apple-Default-CMM on Macintosh and Windows platforms which is to a degree publicly documented.

Members should carry out all arising color transformations exclusively with ICC-profiles and thereby use the operating system's ICC-mechanism or other ICC-compatible transformation techniques, e.g. under Post-Script-Level-2/3.

All printing houses that are either members of the ECI or work according to the ECI-Guidelines provide their preferred ICC-profiles for edition printing on the ECI server. The profiles are then available for all involved on the homepage: »<http://www.eci.org>«. The following data should be contained in the profile-packet:

- the ICC-CMYK-profile with the date in the file name
- an information file to the ICC-profile with the following details
 - printing house' address and contact
 - date of profile production
 - printing process (e.g. sheet-fed offset, rotary offset, gravure etc.)
 - measuring technique used
 - measuring conditions for the profile production
(recommendation: one-sided print out of test chart, measuring conditions according to ISO 13655: CIE-LAB, 0/45 or 45/0, D50, 2°. Exception: Underlay for measuring the test chart 3 sheets of edition paper, or least white paper)
 - software used for profile production
 - separation settings: UCR/GCR, black ink limit, total ink limit etc.
 - the default CMM set in the profile
(recommendation: Apple-Default-CMM as of ColorSync 3.x for Macintosh and Windows)

- the ICC-profile's CIELAB-measuring data based on the color chart ISO 12642 (IT8.7-3, example: see Appendix 8). The characterization chart with the measurement data must contain at least the measured CIELAB-values, the CMYK-values, the correct alphabetical and numerical indicators of the measurement areas as well as a completed File-Header.
- An information file with recommendations as to how the measurement data is calculated, if necessary, as an ICC-profile (software, profile size, separation settings: UCR/GCR, black ink limit, total ink limit etc.). This information is covered in part by those given for the produced ICC-profile.

All those involved who carry out color transformations for different printing houses can either use the ICC-profiles on the ECI server or produce appropriate ICC-profiles according to the printer's characterization charts (measuring data) and use these for the color adjustment. The recommendations for producing the profiles (black generation etc.) should be hereby considered.

It is the responsibility of the printing houses to always provide up-to-date ICC-profiles or characterization charts on the ECI server, and the responsibility of those involved to call up the up-to-date profile. As a rule, the

gravure printing houses provide their individual ICC-profiles on the ECI server. Many printing houses print according to one printing standard, e.g. BVD/FOGRA (corresponds extensively to DIN/ISO 12647-2) and do not provide individual ICC-profiles. Reproduction businesses can, in agreement with the printing house, use a generic ICC-profile for color adjustment and proofing, e.g. ICC-profiles based on the FOGRA-characterization charts for different paper classes. The data and some profiles for this can be called up on the ECI server (<http://www.eci.org>*) or at »<http://www.fogra.org>«.

*future address of the ECI homepage. If necessary »<http://www.kommtech.uni-wuppertal.de/eci>« is still valid.

4. Establishing the Proof

A proof is the material, color illustration of files and serves as a data control. Different control criteria make sense in the different phases of the production of a print file. On one hand the visualization of material, structural properties is to the fore, on the other the stipulatory color simulation of the printed result is called for. In the following, the points for usage, control functions, manufacture conditions and responsibilities are stipulated for different proof variations that appear in the ICC-workflows as described by the ECI.

Generally, every ICC-proof should contain a footnote with at least the following information:

- Date and time of production
- correct file name of the data
- simulation for which printing house / printing process?
- ICC-source profile (correct profile-file name)
- ICC-target profile (correct profile-file name)
- if necessary, the ICC-simulations profile (correct profile-file name)
- proofing system

For use with proprietary proofing systems, the proof's footnote should contain the following entries:

- Date and time of production
- correct file name of the proofed data
- simulated printing process, if necessary the color adjustment curve used
- proofing system, if necessary the date of the last linearization

When working with a »JobTicket« (see Chapter 5), all proof-information can be stored in the JobTicket-file. In this case, each proof should be marked with an identification number / contract number which refers to the appropriate JobTicket.

4.1 »Idealized ICC-Proof«

What is understood here by »idealized ICC-proof« is the print-out of LAB-data or also of »standard«-RGB-data (referred to as »ECI-RGB« in the following) with the proofing system's maximum color range of (»Full-Gamut-Proof«). It serves for the agreement on the structuring of contents of files, for example of adverts, between a creative agency and an art studio or a repro department. The »idealized ICC-proof« does not represent the expected color in the printed result. With this expressed, the LAB-proof can also serve for the agreement on correction with the client (e.g. advertising customer).

The »idealized ICC-proof« can be made directly from the application file (e.g. Photoshop or QuarkXPress) When producing the idealized proof, the LAB-data or ECI-RGB-data to be printed should be transformed with appropriate ICC-profiles to the proofer's (color printer's) color space and then printed out (diagrams 4.1-1 and 4.1-2). The ICC-color reproduction option »perceptual« can be used for pixel images. The print result in its color range is LAB or ECI-RGB, "cropped" by the proofer's actual, depictable CMYK-color space.

Especially the CMYK-color ranges of proofers are relatively large in comparison to the attainable color ranges of traditional printing processes. In no case should the LAB or ECI-RGB-data be printed out on the proofer without the appropriate ICC-transformation, otherwise an internal conversion to an unclearly defined CMYK-space will occur, either in the application software, printer driver or in the output device's PostScript RIP, and the CMYK produced will not be representative of the proofer's complete color range.

The Ugra/FOGRA CIELAB-media wedge should be proofed together with the print-out. This wedge (LAB D50) should, if necessary, be transformed for now with the appropriate ICC-profile and the »relative colorimetric« reproduction option to the color space of the pixel image (e.g. ECI-RGB, LAB D65) and then with the appropriate ICC-profile and the same method (»perceptual«) as used for the transformation of the pixel image to the proofer's color space (diagrams 4.1-1 and 4.1-2).

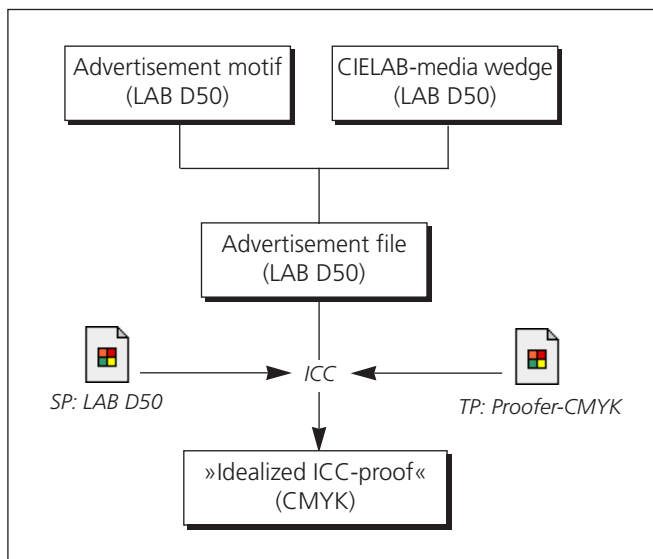

Diagram 4.1-1:
»Idealized ICC-proof«,
proofing LAB-Data

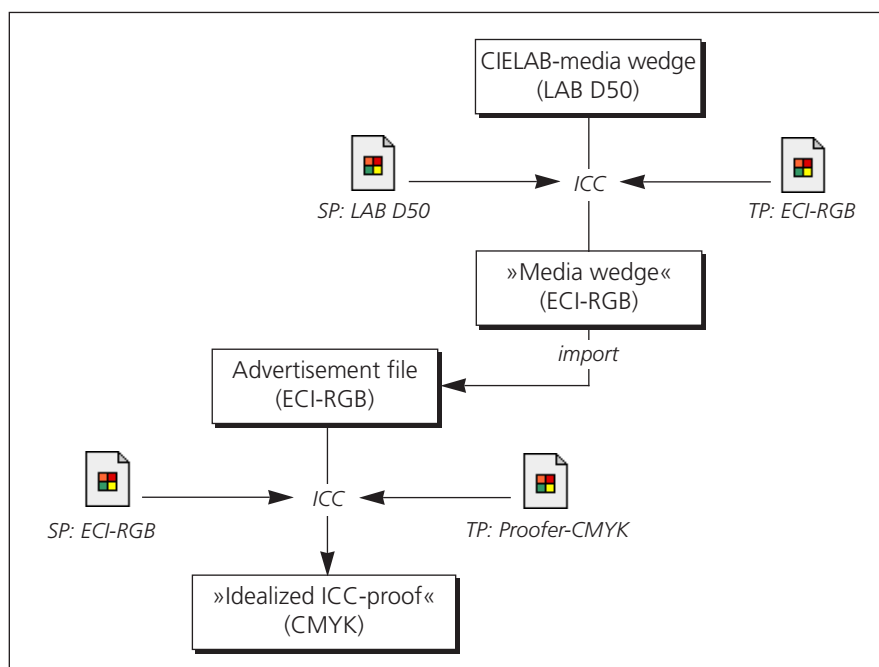

Diagram 4.1-2:
»Idealized ICC-proof«,
proofing ECI-RGB-Data

SP: »source-profile«, TP: »target-profile«

4.2 »ICC-Proof« (»ICC Contract Proof«)

The »ICC-proof« shows the color and material simulation of the edition print in a specific printing process with a particular type of paper. Above all it serves as a contract proof for the printing house but also, for example, for the agency, client or the publishers as a visualization of the color range to be expected in print.

This proof should simulate the following criteria of the edition print as precisely as possible (within a tolerance agreed on by all involved):

- the color appearance of images, graphics, special colors (visual judgement),
- the dot gain or tonal changes (implicitly in images, graphics, colors),
- the paper tone,
- process-inherent features such as loss of tones in highlights,
- if necessary the colorimetric measured values (e.g LAB, XYZ) of the chromatic color areas of the proofed Ugra/FOGRA-CMYK-media wedge (evaluation of measurements).

The ICC-proof should be made by the data producer / data supplier from the prepared transfer data (PDF-exchange file) and passed on to the receiver together with the digital data. For the purpose of a data-output control, the data should preferably be proofed directly from the transfer data carrier. In this way it can be determined whether all necessary resources (fonts, high-resolution data etc.) are at hand.

When producing the proof the color data should be transformed with appropriate ICC-profiles from the source color space via the simulation color space (production print process) to the target color space (proofing system) (diagram 4.2-1). For this, the ICC-profile for the individual production print process should be used as the simulation profile. For ICC-proofs on paper that corresponds to the edition paper of the production print, the »perceptual« ICC-rendering intent should be used for the transformation stage from the source color space to the simulation color space (production printing) and »relative colorimetric« for the stage from the simulation color space to the target color space (proofer).

Note: if the data is already in an adjusted composite-CMYK for an edition printing process then the first transformation stage is omitted. The CMYK-data should then be converted with the appropriate ICC-profile to the proofer's color space (diagram 4.2-2). When printing on paper which corresponds in color to the edition paper, the »relative colorimetric« rendering intent should be used, otherwise the »absolute colorimetric«.

One of the Ugra/FOGRA media wedges should be proofed together with the print-out. The wedge should be already layed down in the exchange file and in the data's color space. If the image data is in the LAB color space then the Ugra/FOGRA CIELAB-media wedge (LAB D50) can be implemented in the file without further ICC-transformations. If the exchange data, for example, is in the ECI-RGB color space, then the Ugra/FOGRA

CIELAB-media wedge should be transformed with the appropriate ICC-profiles and the »relative colorimetric« reproduction option to the ECI-RGB color space and imported into the exchange file. If the exchange data is in an adjusted composite-CMYK, then the Ugra/FOGRA CMYK-media wedge TIFF from FOGRA should be imported into the exchange file without further ICC-transformations.

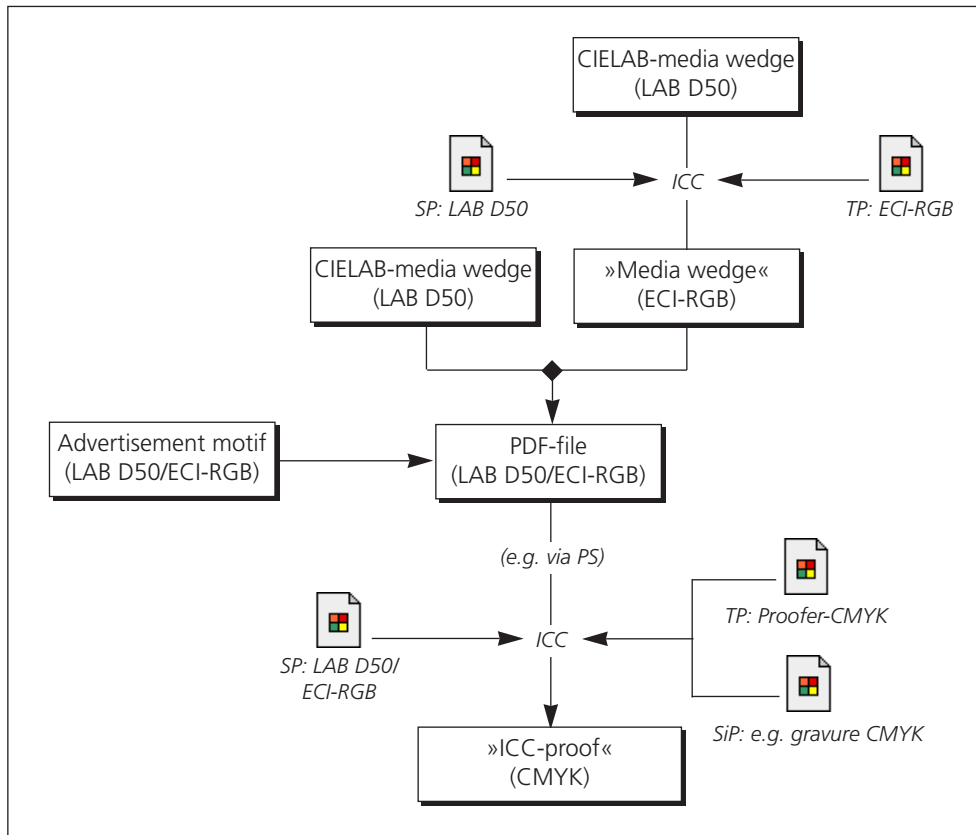

◆ »or«
Diagram 4.2-1:
»ICC-proof«,
proofing CIELAB-Data or
ECI-RGB-Data



Bild 4.2-2:
»ICC-proof«,
proofing CMYK-Data

SP: »source-profile«, SiP: »simulation-profile«, TP: »target-profile«

4.3 »ICC-Proof with Generic Profiles« (»ICC Contract Proof«)

In principle, this proof is produced in the same way as the »ICC-proof« described in section 4.2. The main difference is the simulation-profile that is used. Under otherwise identical conditions (rendering intents), appropriate »generic ICC-profiles« are used as simulation-profiles after agreement between the data supplier and data receiver, for example the ICC-profile for the »reference color space gravure« or the ICC-profile according to DIN/ISO 12647-2 (BVD/FOGRA offset-standard). Generic profiles, in this context, describe all those profiles which have been produced on the basis of a printing norm or with characterization data standardized by many businesses.

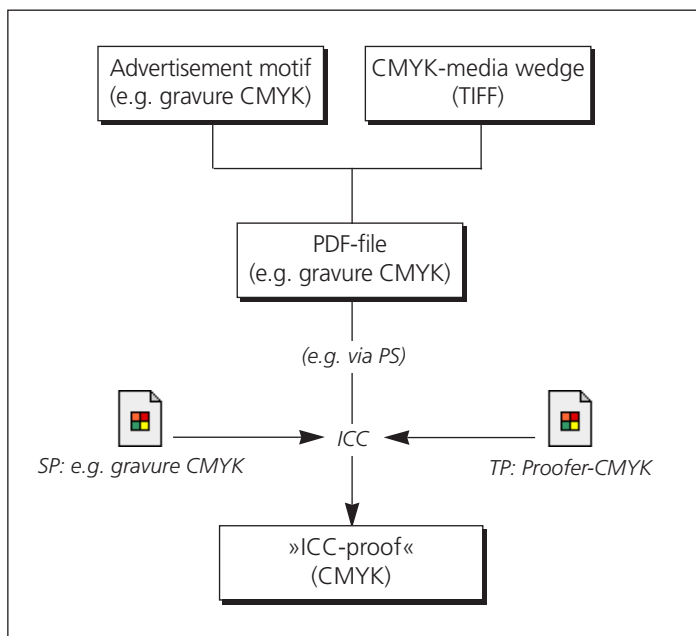
Because the color separation of CIELAB, ECI-RGB or also standard CMYK-data for the actual edition print is not necessarily done with the generic profiles used for the proof, but with manufacturer-specific profiles, the »ICC-proof with generic profiles« only simulates the edition print approximately. If, for example, an advertisement is delivered to a number of publishers in LAB-PDF format, the agency / repro department can pass on an »ICC-proof with generic profiles« to the publishers instead of an »idealized proof«.

If the exchange data, however, is separated for the edition print with the generic profiles used for the proof, then the proofed result represents precisely the production print. The »ICC-proof with generic profiles« hereby becomes the »ICC-proof« as described in section 4.2.

4.4 »ICC-Soft Proof«

What is understood here by »ICC-soft proof« is the simulation of the expected print result of color data on the monitor. Above all it assists the scanner operator in the color assessment of the file in the process-specific preview-mode.

Note: for the display of a soft proof, the digital color data is converted internally (temporarily) in the running software application with appropriate ICC-profiles from the source color space (e.g. ICC-scanner profile) through the simulation color space (printing process) to the monitor's color space (individual ICC-monitor profile). For the depiction of the paper tone, the »absolute colorimetric« reproduction option should be used for the transformation stage between simulation color space and the monitor color space. If the paper tone is not to be simulated then the »relative colorimetric« should be used for this transformation stage. For the conversion stage between the source color space and simulation color space, »perceptual« is mostly chosen in both cases.

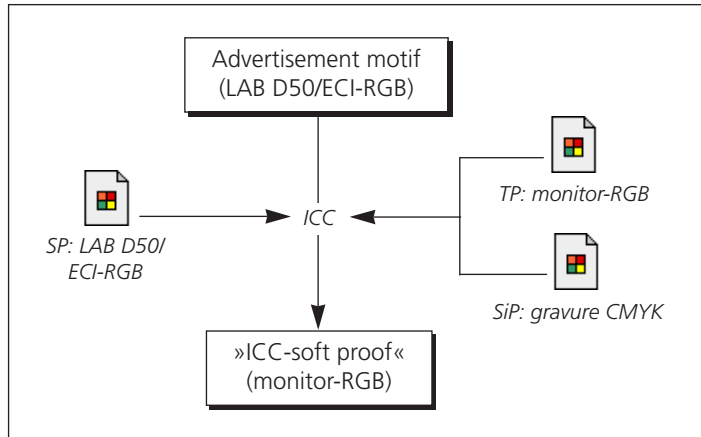

Diagram 4.4-1:
 »ICC-soft proof«,
 CMYK-preview of CIELAB-data

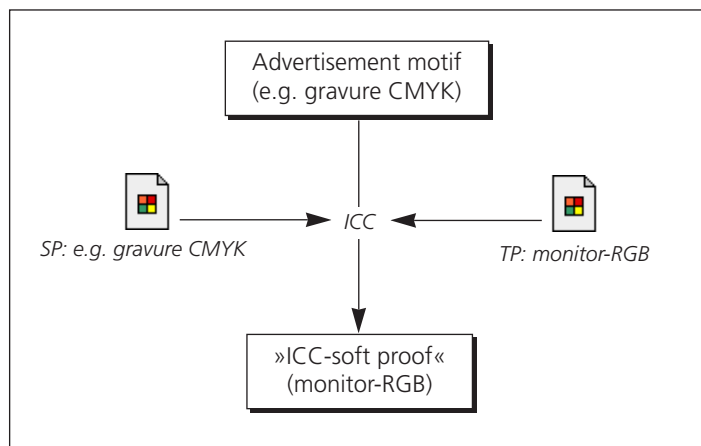

Diagram 4.4-2:
 »ICC-soft proof«,
 true color depiction of CMYK-Data

SP: »source-profile«, SiP: »simulation-profile«, TP: »target-profile«

4.5 Proprietary Digital Proofing Methods

In the category of »proprietary proofing methods« fall all those color adjustment systems (software solutions) that do not work on the basis of color profiles according to the ICC-standard. These systems are not recommended by the ECI. The exchange of the color adjustment curves or mechanisms for the different printing houses is limited, even between proofing systems of the same type,

- because as a rule they are dependent on the printing material (paper tone) used with the proofer
- because they possess extensive editing functions with which it is possible to produce a proof result which cannot be met in print with the digital color data. For ICC-based proof processes, the same ICC-profile should be used for the color simulation and the separation of the digital data for the production print.

Should the proprietary proofing process be used however, then the same criteria apply as for the contract proof described in section 4.2. But because the ICC-profile format is platform and hardware independent, the actual proof printers can be ICC-profiled and so used for ICC-based proofing processes.

5. Administrative Communication between »Data Supplier« and »Data Receiver«

Important information for the data receiver about the exchange data and instructions for its finishing (e.g. job data, printing instructions etc.) can vary greatly in different production scenarios (e.g. advertisement production, catalogue production). Their content and the ways of communicating them are not laid down in these guidelines. The only exception is ICC-information to ensure a faultless, ICC-based finishing of the transfer data. This section establishes which ICC-information needs to be passed on to the data receiver about the exchange data and the ICC-proofs which are supplied with it

All information and regulations for the exchange data can, in the future, be organized with a universal, extensive, digital »JobTicket«, which is being developed in co-operation by the software manufacturers »Cal-las«, »ZMG« and »Hermstedt« as well as the ECI team »JobTicket«. The JobTicket's task, among other things, is to document administrative and technical descriptions of the production data – from the planning and organization through creation and finishing to output. Today the almost exclusively fully-digital production environment in the media industry provides a good base for collecting, as far as possible, all relevant information fully automatically with suitable query and input processes. This has the advantage that only authentic information finds its way into the JobTicket.

To ensure that the data receiver can finish the transfer data correctly and true to color in his ICC-workflow, the following information (along with individual contract information) should be enclosed with the file and ICC-proof:

1. Concerning the file

- Color space of data in exchange file (according to the specifications in Chapter 7)
- ICC-color transformation
 - Target-profile (correct file name)
 - Target-profile (supplied in addition / embedded)

2. Concerning the ICC-proof

- Description of proofing system
- ICC-transformation
 - Source-profile
 - Rendering intent
 - Target-profile
 - Simulation-profile (if applicable)
 - Rendering intent (if applicable)

The ICC-entries in the exchange file should also be documented for all other ICC-processed intermediate data and passed on internally to the next colleague. If a JobTicket is not being used then the ICC-information can be conveyed in a PDF-form which can be made interactive with input fields, buttons and blend-in menus.

6. Basic Workflow for Digital Processing of Printed Material

If one looks at the modern, technical »journey through life« of a print file, one can see that regardless of the type of printed material (advertisements, catalogues, magazines, prospectuses, jobbing work, newspapers), it is in principle always made up of the same partial processes:

In a creative phase an »idea« is nowadays usually converted to a digital layout, which consists of an arrangement of text, images and graphic elements, some in form of place-markers. Parallel to this, or shortly after, this is realized, either analogous or digitally, as reproduction-ready copy according to the layout. The extensiveness of the creative work is dependent on the printed matter. While an advertising campaign, for example, goes through a long, specialized creative process, the creative design phase for the layout of a product catalogue is much less.

The conversion of the layout to printable final pages follows in a technical reproduction phase. This includes the digitizing of analogue copies, image editing, if necessary the final text input and finally the completion of the layout and the imprimatur. The creation of the layout and the conversion to printable final pages usually occurs nowadays in the same application.

The preparative stages of work for the later data output already begin after the layout phase. The proprietary application format of the printable final pages is converted next to the standard page description language PostScript and then finally to the device and platform-independent data-transfer-format PDF. While the creative and technical preliminary stages grow closer together in space, time and process technique in the course of digitizing workflows, the repro-technical stage is often separated from the print-technical finishing. There is a clearly visible point of data transfer.

The PDF-data is now run through a print-technical finishing process. According to main point of production, type of printing material and type of printing process, the PDF-data can run through very individual stages of process in this phase. This includes, for example, imposing the final pages in PDF or PostScript format, ripping the data in a proprietary machine language and printing forme production (e.g. CT-P, offset plate making, cylinder engraving etc.). Finally comes the edition print process. Exceptions are press-ready advertisements. These are usually only a part of the page and must be placed in the final pages of, for example, a publication before the actual output for printing. An advertisement which in principle has been processed ready for print, again becomes a page element in a layout file.

Naturally the basic workflow, sketched out here as it is technically realizable today, is in constant change. The production and output today of PDF-data still often requires the (temporary) intermediate pro-

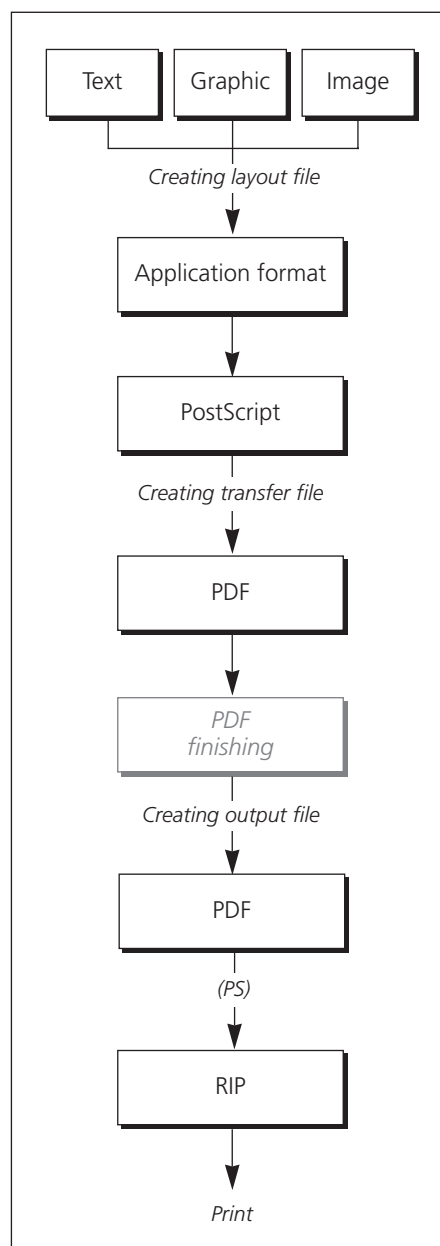

Diagram 6-1:
Technical journey through life of print data

duction of PostScript-data. In the future this step can be omitted. A marvellous overview of the developments, advantages and disadvantages as well as the production and processing of PDF can be gained from the four »Vision&Work Brochures« PDF-Workflow – Basics, Management, Creation and Production by Mr. Stephan Jaeggi. These are available from »<http://www.prepress.ch>«.

On the strength of this basic workflow, »Technical Specifications« are established in Chapter 7 for print-ready transfer data between the repro stage and print preparation. The demands for the transfer data differ according to the type of printed matter and/or the main point of production / printing process. The structuring of the different, individual workflow variations is also dependent on these factors. Which ICC-color transformation steps can be best placed in which stages on the side of data supplier and receiver, is described in »Recommendations for the Adaptation of ICC-Workflows...« in the appendix. The specifications for the transfer data are so flexible that the recommended ICC-workflows can be realized.

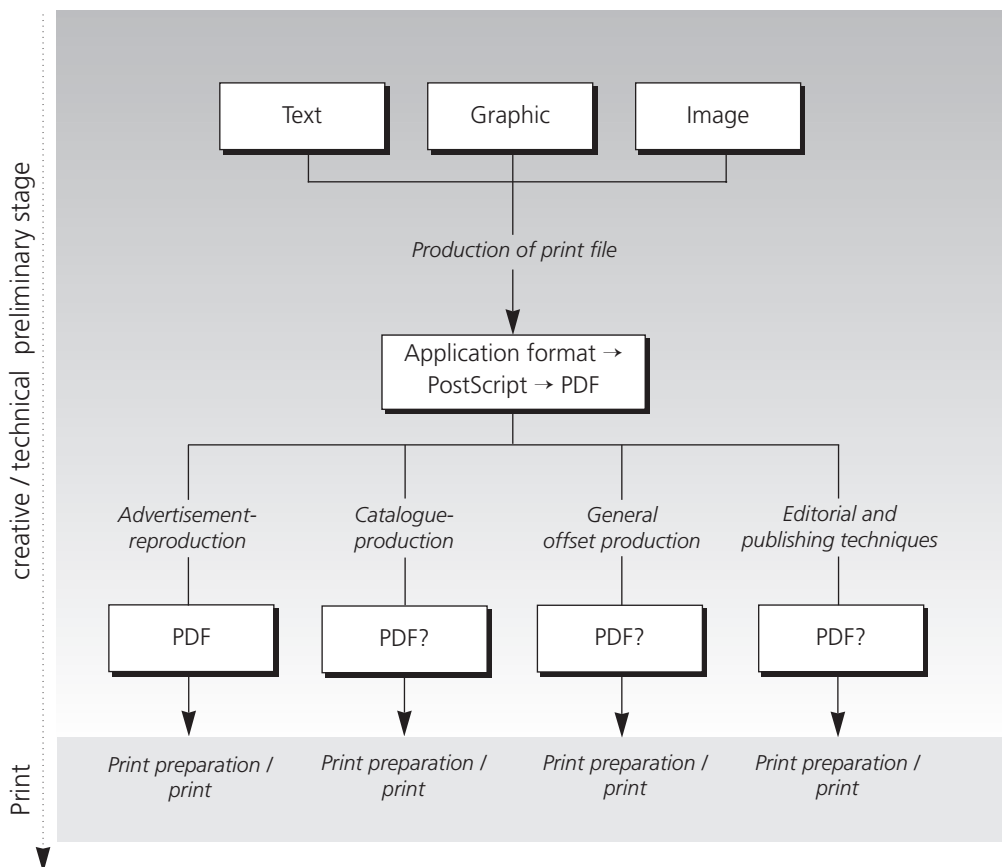

Diagram 6-2:
 Formats in the basic workflow. While the finishing processes between the creative and technical preliminary stages flow smoothly into each other, the interface to printing is clearly noticeable.

7. Technical Specifications for the Exchange of Advertisement Files

The following specifications establish the technical demands for the transfer data of advertisements between repro and the publishing/printing house. One characteristic of advertisements is that during an advertising campaign they appear much of the time in different publications, produced with different printing processes. So it seems reasonable first of all to create the advertisement in a device-independent color space and, from this master data file, produce further files with individual process-specific ICC-color transformations. In which production phases these ICC-adjustments can be carried out can be very individual and dependent on numerous technical and cost factors. The specifications for the exchange file are drawn up in such a fashion that they can be process-specifically ICC-adjusted by either the data supplier or the data receiver (flow charts 7-1 and 7-2). Appendix 1 makes recommendations for the adaptation of ICC-workflows for advertisement production.

7.1 Exchange Format

Composite-**PDF** should be used as the exchange format for advertisement files. The PDF-file should be made from a (temporary) **Postscript Level 2/3** file. The use of the **Acrobat-Distiller-PPD** is recommended for producing the PS-file in order to create an extensively device-independent PS. Notes for producing a trouble-free »HighEnd-PDF« can be found in Appendix 10. The PDF-exchange file should be complete in content for the print output and contain all relevant components (fonts, high-resolution data etc.).

7.2 Exchange Color Spaces

Generally, all color information for pixel images in the PDF-file should either be present as device-independent, colorimetric with supplied / embedded ICC-profiles or specified by exact color definition (e.g. particular CMYK-combinations). The following color spaces have been established by the ECI as exchange color spaces:

- **LAB (D50)** (in accordance with ISO 13655)
- **»ECI-RGB«** with appropriate ICC-profile
- **Defined RGB** with appropriate ICC-profile (e.g. the RGB-working color space in Photoshop 5.0)
- process-adjusted **Composite CMYK** with appropriate ICC-profile
- **Standard-CMYK** as composite-file in accordance with DIN/ISO 12647-2 (BVD/FOGRA offset-standard) with appropriate ICC-profile.

All pixel images, with the exception of special color images (e.g. duplex, triplex) should be integrated in the PDF-file in a uniform color space (Pixel »all-in-one«). Color vector information such as colored headlines or logos can be laid down in separate color spaces to the pixel images (e.g. special colors or defined CMYK-combinations). CMYK-data should be passed on to the receiver as composite-files. Pre-separated image formats such as the EPS-variation DCS (Desktop Color Separated) should *not* be contained in the file.

7.3 Overprinting and Trapping

Trappings are process-specific parameters and can first be defined in the process-specific CMYK after the ICC-transformation. Generally the trapping settings should occur as far back as possible in the production chain. In which stage of production these settings should be made – for example in application software, imposition software or in a PS-RIP – depends on the individually structured ICC-workflow.

7.4 Process and Data Control

One of the Ugra/FOGRA **media wedges** should be integrated into the PDF-advertisement file in the same color space as the image data for the control of the color information and its finishing. The media wedge is available in two variations, as a CIELAB-wedge and as a CMYK-wedge (see Appendix 5). In the transfer of LAB-data the CIELAB-wedge can be used without further ICC-transformations. In the transfer of ECI-RGB-data the LAB-wedge must be transformed to the ECI-RGB-color space of the image data with the appropriate ICC-profile and integrated into the transfer file. If CMYK-data is exchanged then the CMYK-media wedge should be placed in the file (detailed explanations of both media wedges can be found in Chapter 5). Control elements should be placed outside of the advertisement's net format.

Note: for the control of the transfer file's contents, so-called preflight-checkers can be used. These programs provide information about the exchange format (version, production etc.), used fonts and their availability, the color space, resolution and data format of images and much more. Most preflight-programs can output a report with all necessary information. These can be passed on to the receiver with the data.

7.5 Proofs

The transfer data should be passed on with an »ICC-proof« or an »ICC-proof with generic profiles« in accordance with sections 4.2 and 4.3. The proofs should be made from the PDF-transfer file preferably directly from the transfer data carrier. The production of appropriate proofs should be done in accordance with the guidelines in Chapter 4. If process-adjusted CMYK-data is to be proofed then the composite-CMYK-data should be printed out.

7.6 Data Exchange Media

In principle, three media can be used for the transfer of digital exchange files, physical data carriers, ISDN (Integrated Services Digital Network), also the Internet for data transmission by e-mail or via an ftp-server (ftp: file transfer protocol). Generally the choice of data exchange medium is discussed between the data supplier and the data receiver. The established material data carriers on the market are e.g. CD-ROM, MOD (600 MB, 1200 MB), ZIP (100 MB) or Jaz (1 and 2 GB).

Because of their simple, safe and cost-effective production, hybrid-CD-ROMS (Mac / ISO 9600) are particularly recommendable and, because of their high compatibility, they require no further discussion between supplier and receiver.

Data Supplier

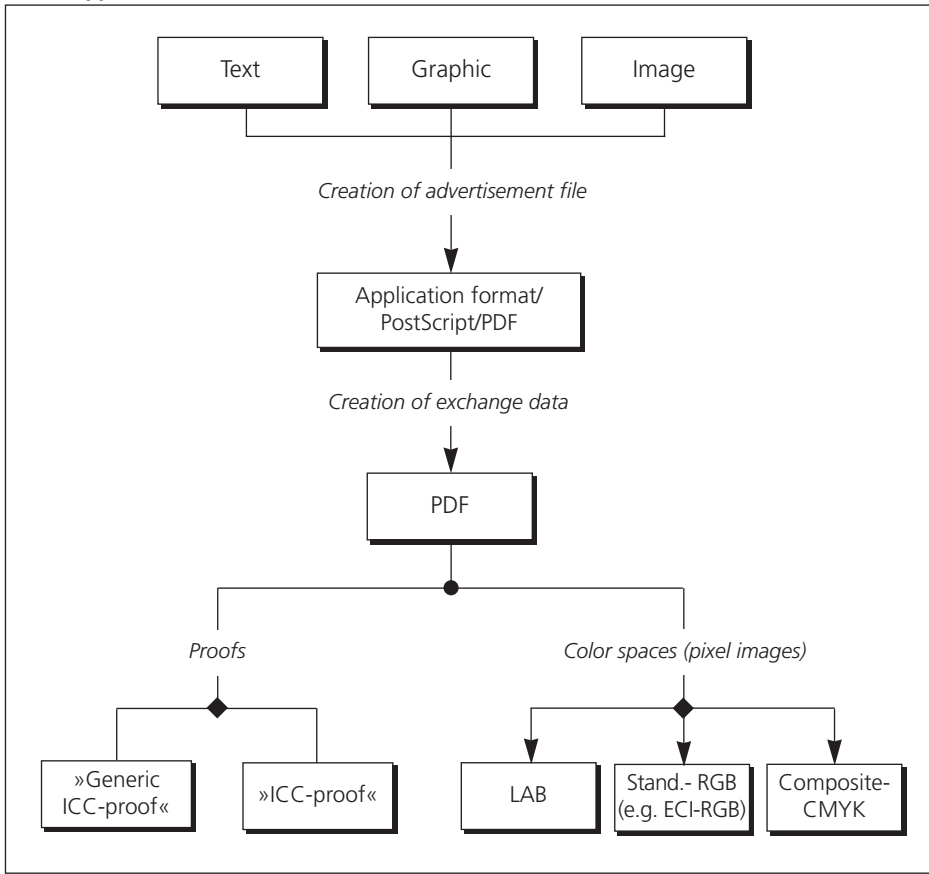

Diagram 7-1:
Creation of transfer data for advertisement files (data transfer variations)

Data Receiver

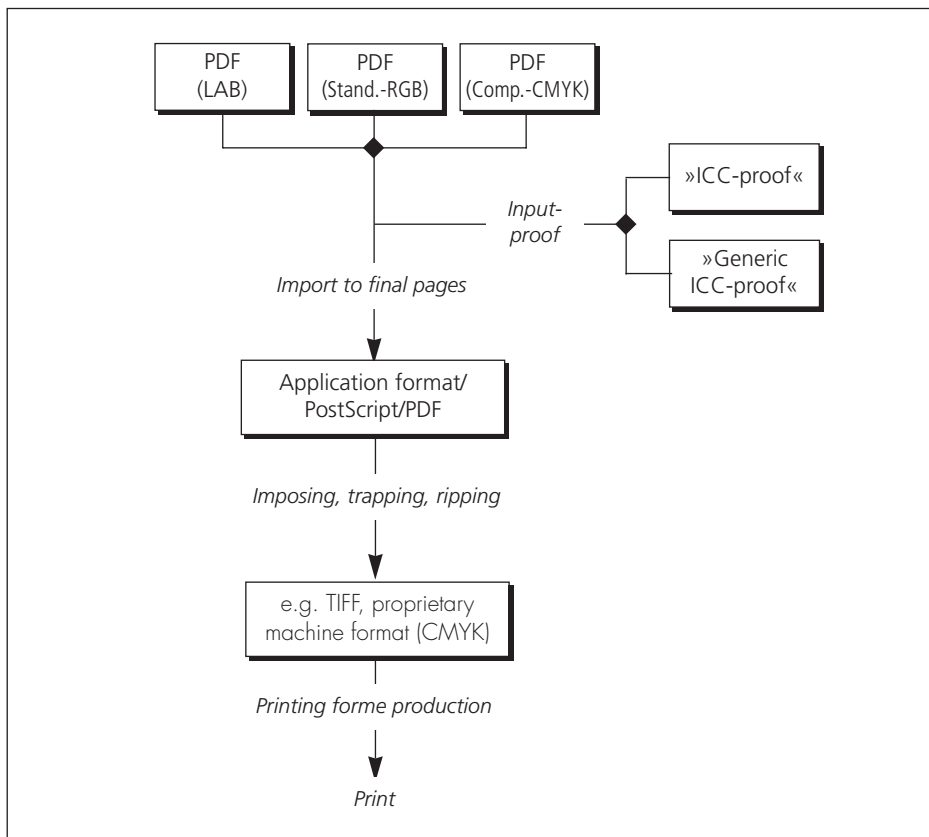

Diagram 7-2:
Finishing the advertisement transfer data



APPENDIX 1

»Recommendations for the Adaptation of ICC-Workflows in Advertising Production«

Contents

- A 1.1: The »Ideal« Workflow and its Limitations
- A 1.2: Transfer of ECI-RGB/LAB-Data with Generic ICC-Proof
- A 1.3: Transfer of Reference-CMYK-Data with Generic ICC-Proof
- A 1.4: Transfer of Process-Adjusted CMYK-Data
with Generic or Individual ICC-Proof
- A 1.5: Comparison of Workflow Variations

APPENDIX 1: »Recommendations for the Adaptation of ICC-Workflows in Advertisement Production«

The following are intended as recommendations for the user as to how ICC-workflows can today be efficiently structured. Depending on the needs of those involved in the production and the software available today with their (available and missing) functions, different »workflow-variations« can be designed. All variations are, however, based on the basic workflow described in Chapter 6 of the ECI-Guidelines, whereby PDF-based data processing is preferred.

The workflow descriptions are conceptual and can be adapted to individual production environments, for example to an OPI-based workflow. The following three workflow-variations are described:

1. The transfer of ECI-RGB/LAB-data with generic ICC-proof between the agency/repro and publishing/printing house
2. The transfer of reference CMYK-data with generic proof between the agency/repro and publishing/printing house.
3. The transfer of process-adjusted CMYK-data with generic or individual ICC-proof between the agency/repro and publishing/printing house.

The variations will first of all be described in concept and then illustrated by means of example. The examples are based on strategically important application programs (Photoshop, QuarkXPress, Acrobat).

A prerequisite for the adaptation of ICC-workflows is that all input and output systems in the chain of production, as well as partial processes, are profiled. The production of ICC-profiles is not detailed within the workflow-recommendations. Furthermore, the PDF-exchange data should be made in accordance with the specifications in Chapter 7 and the proofs in accordance with the guidelines established in Chapter 4 of the ECI-Guidelines.

A 1.1: The »Ideal Workflow« and its Limitations

One characteristic of advertisements is that during an advertising campaign they appear much of the time in different publications (magazines, newspapers etc.). These different publications are printed in different printing houses with individual printing processes. Normally many individual process-adjusted CMYK-data files of the same advertisement motif are required for the different printing processes (e.g. gravure, offset).

In an ideal ICC-workflow for the production of advertisements, the image data is prepared device-independently in the creative and technical preliminary stages and transferred to the printing houses. The process-specific ICC-adjustments for the different printing processes would be made by the printing house directly from the neutral database (diagram 1). At the same time the printing house would receive an »idealized ICC-proof« which depicts the device-independent data within the boundaries of the proofer's color space only. In this way, agencies/repro studios can produce a universal, neutral proof for all printing houses. The creative/technical preliminary stages are responsible for the correctness of the contents in the transfer data as well as its device-independence and the printing house is responsible for the quality of their ICC-profiles as well as the best possible color adjustment of the data.

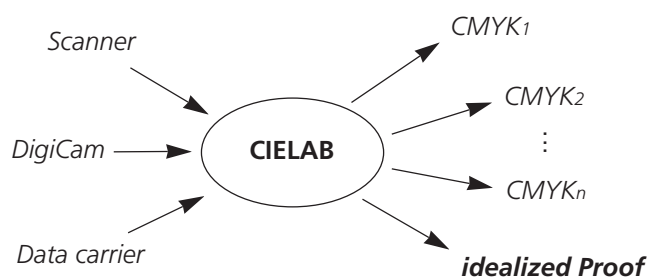

Diagram 1: Print data and proof are made directly from the device-independent data.

This simple, ideal workflow cannot be adapted at present for different reasons. Some reasons, among others, are:

- 1) At present, a standard-RGB (referred to here as ECI-RGB) has established itself as a print process independent color space in an 8 Bit orientated work environment. CIELAB is not consistently supported in today's work environment. Some businesses, however, do use CIELAB and achieve good results in production. Nothing changes in the workflow when using RGBs or CIELAB, and so in the following descriptions the ECI-RGB and LAB-workflows are combined together.
- 2) When transferring device-independent data together with an »idealized proof« (CIELAB proof or standard-RGB proof within the color space limits of the proofing system), the latter is not critical enough for judging the color adjustment to the transfer data.

Because one aim of the device-independent data transfer is to be able to produce the data without necessarily having knowledge of the output process, it is not always possible for the pre-press service to pass on

process-individual profiles to the data receiver. The compromise is a »generic CYMK-proof« which simulates a »process-typical« standard-CMYK (see ECI-Guidelines, Chapter 4) for all data receivers.

3) After the color transformation of the device-independent data, a corrective step in the process-adjusted CMYK-data file is sometimes necessary. Generally two corrective phases are to be decided between in the device-independent or print process independent ICC-workflow, the creative and the process-specific corrections. Creative retouchings, where possible, are carried out in the neutral data file and the process-specific color correction to the adjusted data file (1-5% CMYK-corrections). If the latter correction phase is necessary, this can only be done by the pre-press service due to data handling and responsibility. Finally the adjusted data should be passed on to the printing house.

At this moment in time and with current technology an alternative is to prepare the image data in the creative and technical preliminary stages, not in the device-independent CIELAB but in a print-process-neutral (reduced in color range) color space (e.g. reference-CMYK) and to carry out the process-specific adjustments on that (diagram 2). The latter stage can either be done in the pre-press stage or in the printing house. According to requirement, the base data can be archived either as device-independent (CIELAB) or print-process-neutral.

In addition, »generic proofs« in a print-process-specific standard-CMYK can be passed on to the printing house instead of an »idealized ICC-proof«. In this way the responsibilities of those involved with the production, as mentioned above, can be met. If the adjustment to process occurs in the printing house then firstly the generic CMYK-proof is sufficient for judging the results and secondly the »color-range-reduced« but print-process-neutral data is less subject to strong gamut-mapping-influence.

Apart from this, with the production of »generic ICC-proofs« (instead of process-individual proofs each time), pre-press businesses can optimize their production time. Furthermore, the objective of not having to conclusively communicate the final printing process between the data producer and the data receiver is likewise realizable.

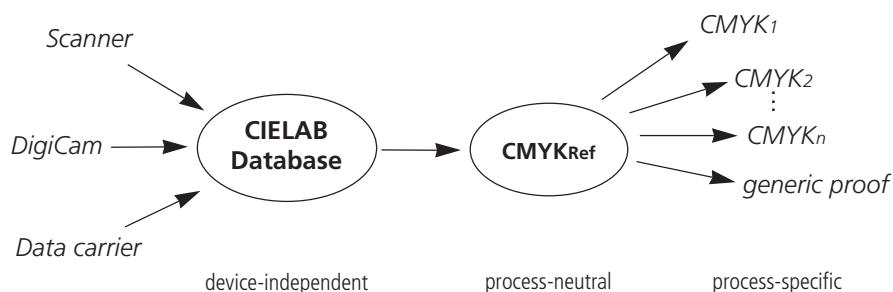

Diagram 2: Print data and proof are produced from print-process-neutral data

A 1.2: Transfer of ECI-RGB-/LAB-Data with Generic ICC-Proof (Diagrams 4-1 and 4-2)

conceptional:

1. The agency/repro digitizes the copies in the RGB-color space of the input system (scanner, digital camera) and carries out an ICC-color transformation in ECI-RGB or LAB and saves the data.
2. The creative image editing is done in the LAB or LCH-mode or in ECI-RGB. The image release can follow between the agency/repro and the customer, for example, on the strength of an »idealized ICC-proof« (visualization within the color space limits of the proofing system, see Chapter 4.1).
3. The construction of the advertisement occurs with ECI-RGB or LAB-data, for example in QuarkXPress.
4. PostScript-data (ECI-RGB/LAB) is produced from the print-ready advertisement data.
5. The PostScript is converted to a PDF-exchange file in ECI-RGB or LAB (in accordance with the specifications in Chapter 7).
6. The agency/repro produces (preferably directly from the data carrier) »ICC-proofs with generic profiles« for the different publishers from the PDF-exchange data (visualization in a reference-CMYK, e.g. according to BVD/FOGRA or in a reference color space gravure, see Chapter 4.3).
7. The PDF-data is passed on to the publishing/printing house together with the »generic ICC-proof«.
8. The publishing/printing house produces process-adjusted »ICC-proofs« from the PDF-exchange data for the different publications or printing processes as contract proofs for the printers (visualization in data receiver's individual process-CMYK). This can be done, for example, with ICC-colorservers (the individual »ICC-proof« can also be produced from the adjusted data as in step 9).
9. Finally, the individual CMYK-data files are produced for the different publications or printing processes from the PDF-data. The adjustment of the CIELAB-data occurs hereby with the appropriate ICC-profiles from the publishing/printing houses.
10. As necessary, the print-adjusted CMYK-data is imported into the layout documents for the different publications. The print preparation then follows (trapping, imposing, print forme production) and then the print.

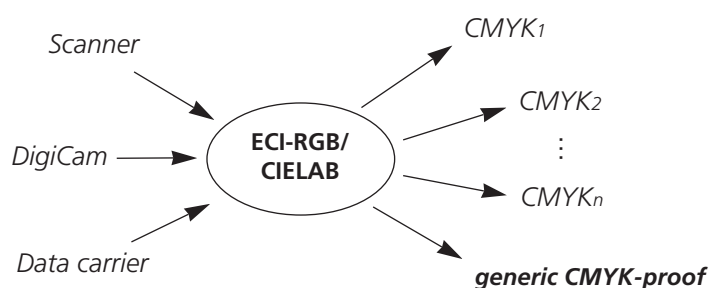
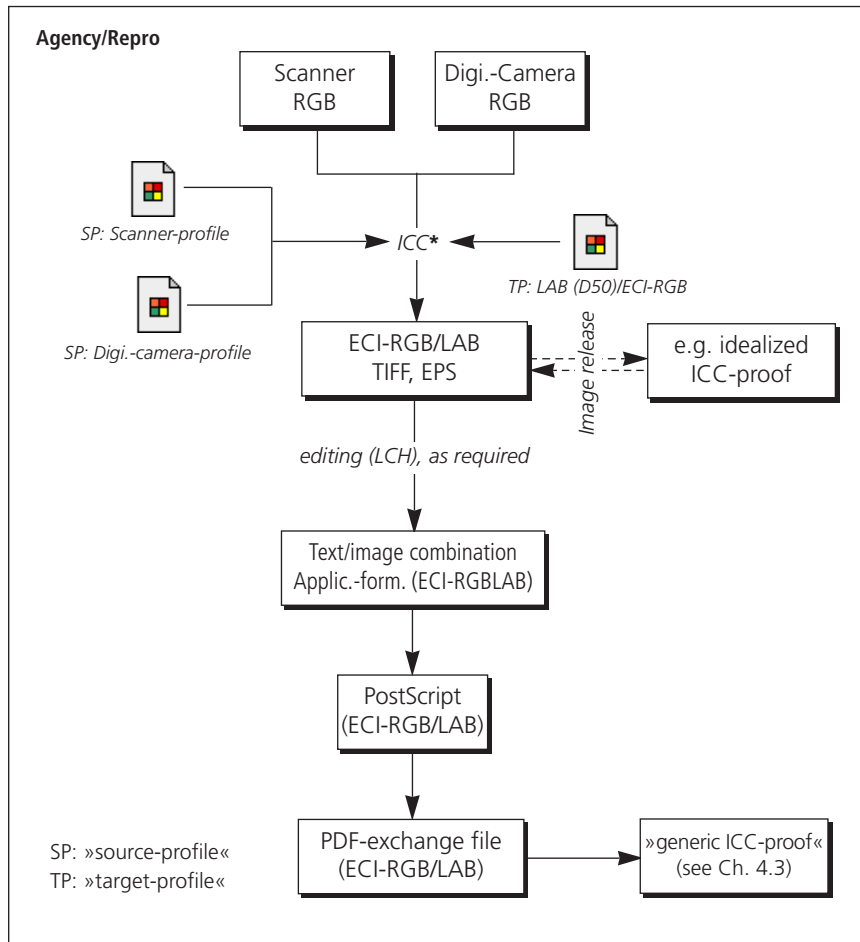

Diagram 3: Print data and proof are produced from device or process independent data. The proof simulates a process-typical reference-CMYK (e.g. gravure or offset)



*»ICC« indicates a color transformation with ICC-profiles

Diagram 4-1:
Production of PDF-data in the ECI-RGB/ LAB color space by agency/ reproduction

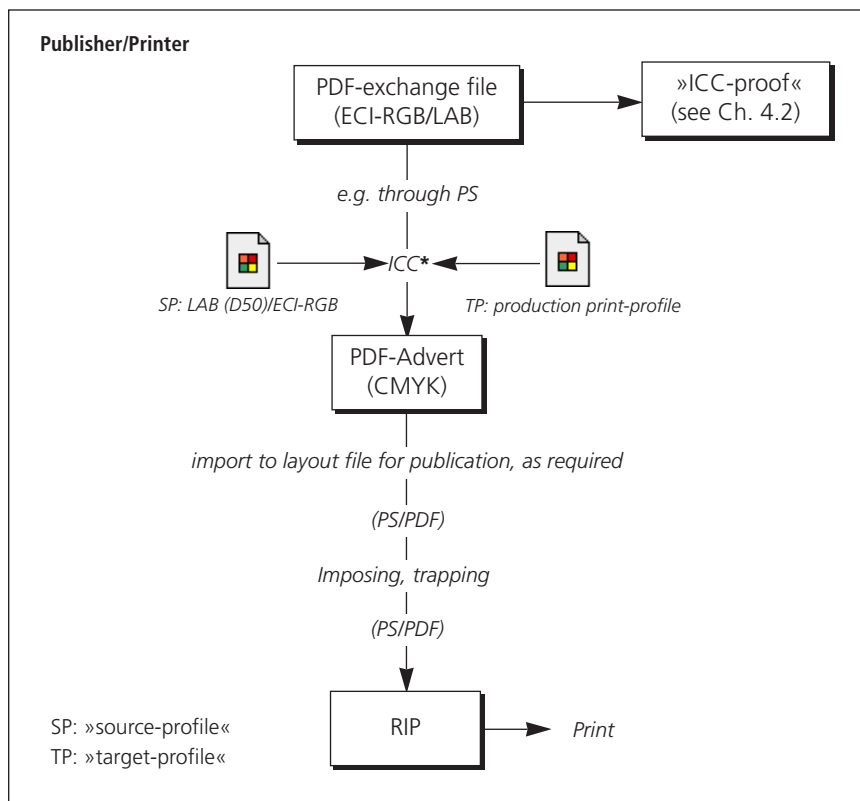

Diagram 4-2:
Editing of PDF-data in the ECI-RGB/LAB color space by the publisher/printer

Example:

Advertisements are to be reproduced device-independently for numerous publications and passed on to the different publishers for finishing. The image editing is done in Photoshop 5.0 and the advertisement is constructed in QuarkXPress 4.0. Both image editing and layout is done on an Apple Macintosh. ColorSync 3.0 is used with the Apple-CMM as default for all ICC-color transformations. Acrobat Distiller 3.0/4.0 is used for the production of the PDF-file and the color adjustment of the ECI-RGB/LAB-PDF-data is carried out through PostScript with »BatchMaker PS«.

The production flow (diagram 4-1) begins with the digitizing of the »copies«. Reflective and transparent copies are scanned in the original scanner-RGB and then transformed to ECI-RGB or CIELAB. The creative working is done in ECI-RGB or CIELAB, for example in Photoshop 5.0. »ECI-RGB« can hereby be set for ICC-color transformations (ECI-RGB-profile) as well as the RGB-working space in Photoshop. For the later import of the ECI-RGB/LAB-data into a QuarkXPress file, they must be saved as EPS. Otherwise the colors will be converted to CMYK during PostScript production.

The evaluation of the retouching work and the indication of the image in a printing process, e.g a reference-CMYK, can be made with the appropriate configuration of Photoshop in the preview-mode (soft proof). For the agreement on color and content between the customer and the agency a »generic ICC-proof« is made with a reference-CMYK as the simulation color space. Because the different, classical CMYK-printing processes differ in color space and the process parameters for the black generation, a »process-typical« reference-CMYK should be used for the proof. Should the ECI-RGB or LAB-color data be later printed in a gravure process, then the »reference color space gravure« is available for the generic proof. The FOGRA-profile, for example, can be used for the offset area. The image data can be adjusted for the proof with the ICC-color-server BatchMaker PS. The source-profile ECI-RGB or CIELAB-profile should be used as the target-profile for the proofing system and as simulation-profile for the reference-CMYK. For the transformation stage of the source system to the simulation color space the »perceptual« rendering intent is used as a rule for images and »absolute colorimetric« for the depiction of the simulation color space within the proofer's color space. If the customer desires further corrections to be made these should be made in the image data and proofed again.

After the image is released for print then follows the text and image combination in the the print-ready final pages in QuarkXPress 4.0. The ECI-RGB/LAB-data should hereby be placed as EPS-files. Special colors in the document are layed down as CMYK-values. This can either be done in QuarkXPress or the appropriate CMYK-values are transferred with the aid of suitable program-tools (LOGO ColorPicker) through a desired ICC-process profile. These measured values can be easily carried over to XPress. In this workflow, for example, the CMYK-values for the »reference color space gravure« can be used.

When the print document is ready, the PDF-transfer data can be produced for the printing house. First of all, composite-PostScript-data must be generated from the layout data in QuarkXPress. It should be noted here that no device-specific printer description (PPD) is to be used, rather the device-independent Acrobat-Distiller-PPD. The Distiller-PPD can be directly selected in the Print-dialogue in QuarkXpress. This has priority over the PPD allocated to the printer driver. Furthermore, the fonts used in the document should already be integrated in the PostScript-file. A marvellous overview of the trouble-free production and processing of HighEnd-PDF-data can be gained from the »Vision&Work Brochures« – PDF Workflow – Basics, Creation and Production by Stephan Jaeggi. These are available from »<http://www.prepress.ch/visionwork/deutsch.html>«.

When producing composite-PostScript, QuarkXPress does not write trapping information for the CMYK-data contained in the document (in this case only for color in vector graphics) into the PostScript. In a modern, device-independent workflow, trapping is set further back in the chain of process, because trapping is process-dependent. Different definitions are used for flexography, for example, than for offset.

The PDF-file is generated from the PostScript-file with help of Acrobat Distiller 4.0. A whole list of settings should be hereby noted for an imageable PDF-file (PDF-brochures »<http://www.prepress.ch>«). In order not to alter the ECI-RGB/LAB-data contained in the PS-data, the option »leave color unchanged« must be selected in the color settings.

The »generic CMYK-proof« for the printing houses, for the purpose of data control, should preferably be made from the PDF-transfer data. Because there are currently no suitable tools for the direct ICC-transformation of PDF (which is sure to change in the foreseeable future), the PDF-data must be converted again to a PS-file beforehand. To do this, the PDF-document can be opened in Acrobat 4.0 and converted to PS via the PostScript-driver with the device-PPD for the proofing system. The PS-data can then be ICC-proofed by means of the ICC-colorserver, e.g. »Parachute« or »BatchMatcherPS«. Outline and pixel data can hereby be color adjusted separately. In BatchMatcherPS, for example, the »reference color space gravure« should be specified as source and simulation profile for those CMYK-colors in vector graphics, if necessary. For the image data, the ECI-RGB or CIELAB-profile should be selected as the source-profile and »reference color space gravure« as the simulation-profile. If a paper is being proofed on which does not correspond in color to the edition paper, then the »absolute colorimetric« rendering intent must be used for the transformation stage from simulation-profile to target-profile. Either »perceptual« or »absolute colorimetric« is used from the source to the simulation color space.

The ECI-RGB or LAB-PDF-documents are then written to CD and passed on to the printing houses together with the »generic ICC-proofs« (diagram 4-2). As described, the PDF-data in the printing house can then be first of all converted to PostScript with the use of a desired device-PPD and then color adjusted in the ICC-colorserver. The source-profile for the CMYK-tones is the »reference color space gravure« and for the image data the ECI-RGB or LAB-profile. As target-profile, the one for the desired printing process is used, e.g. an individual gravure-profile. An individual ICC-proof is now made from the adjusted PS-data as a contract proof for the printer. This is also done with the ICC-colorserver.

After the PS-data is color adjusted it can be run through the further editing processes in the printing house. The composite-PS-data now contain only process-adjusted CMYK-data. As a rule they undergo no further changes in the following processes. When editing device-independent data, the trapping will, in the future, come at the end of the chain of production. This means that in the future the printing houses will deal with the trapping, e.g. direct in the PS-RIP (example xxx???)

A 1.3: Transfer of Reference-CMYK-Data with Generic ICC-Proof (Diagrams 4-1 and 4-2)

conceptional:

1. The agency/repro digitizes copies in the RGB-color space of the input system and then carries out an ICC-color transformation in ECI-RGB or LAB and saves the data.
2. The creative image editing is done preferably in the LAB-mode or in ECI-RGB.
3. The final LAB or ECI-RGB-data is converted to a reference-CMYK (e.g. reference color space gravure, FOGRA offset standard) by means of an ICC-color transformation.
4. The image release can follow between the agency/repro and the customer on the strength of a »generic ICC-proof« (visualization in a reference-CMYK, e.g. according to BVD/FOGRA or in the reference color space gravure, see Chapter 4.3).
5. The construction of the advertisement occurs with the reference-CMYK-data, for example in QuarkXPress.
6. PostScript-data (reference-CMYK) is produced from the print-ready advertisement data.
7. The PostScript is converted to a PDF-exchange file in the reference-CMYK (in accordance with the specifications in Chapter 7).
8. The agency/repro produces (preferably directly from the data carrier) »ICC-proofs with generic profiles« for the different publishers from the PDF-exchange data (in accordance with the guidelines in established in Chapter 4.3).
9. The PDF-data is passed on to the publishing/printing house together with the »generic ICC-proof«.
10. The reference-CMYK-data is either processed by the publisher/printer without further color adjustment or converted to the individual CMYK-color space (CMYKref → CMKind.) by means of an ICC-color transformation.
11. The publishing/printing house (depending on step 8) produces individual process-adjusted »ICC-proofs« from the PDF-input data (visualization in data receiver’s individual process-CMYK, see Chapter 4.2) or »generic ICC-proofs« for the different printing processes as contract proofs for the printer. This can be done, for example, with ICC-colorservers (the individual »ICC-proof« can also be made from the reference-CMYK-data before step 8).
12. As required, the print-adjusted CMYK-data is imported into the layout documents for the different publications. Finally comes the print preparation (trapping, imposing, print forme production) and then the print.

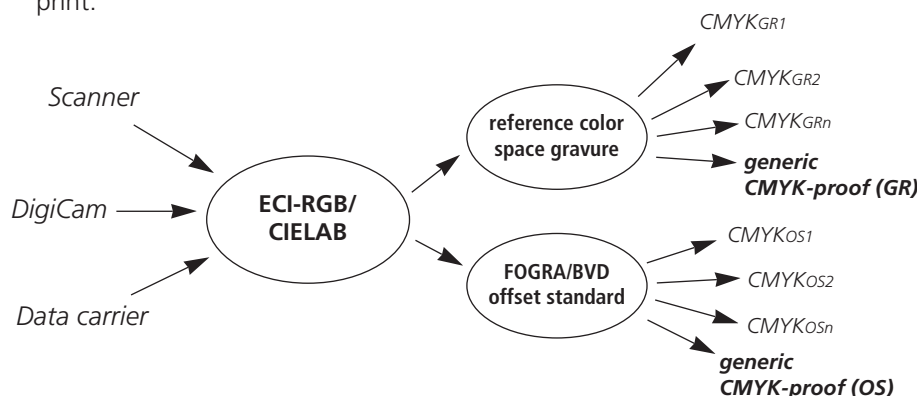
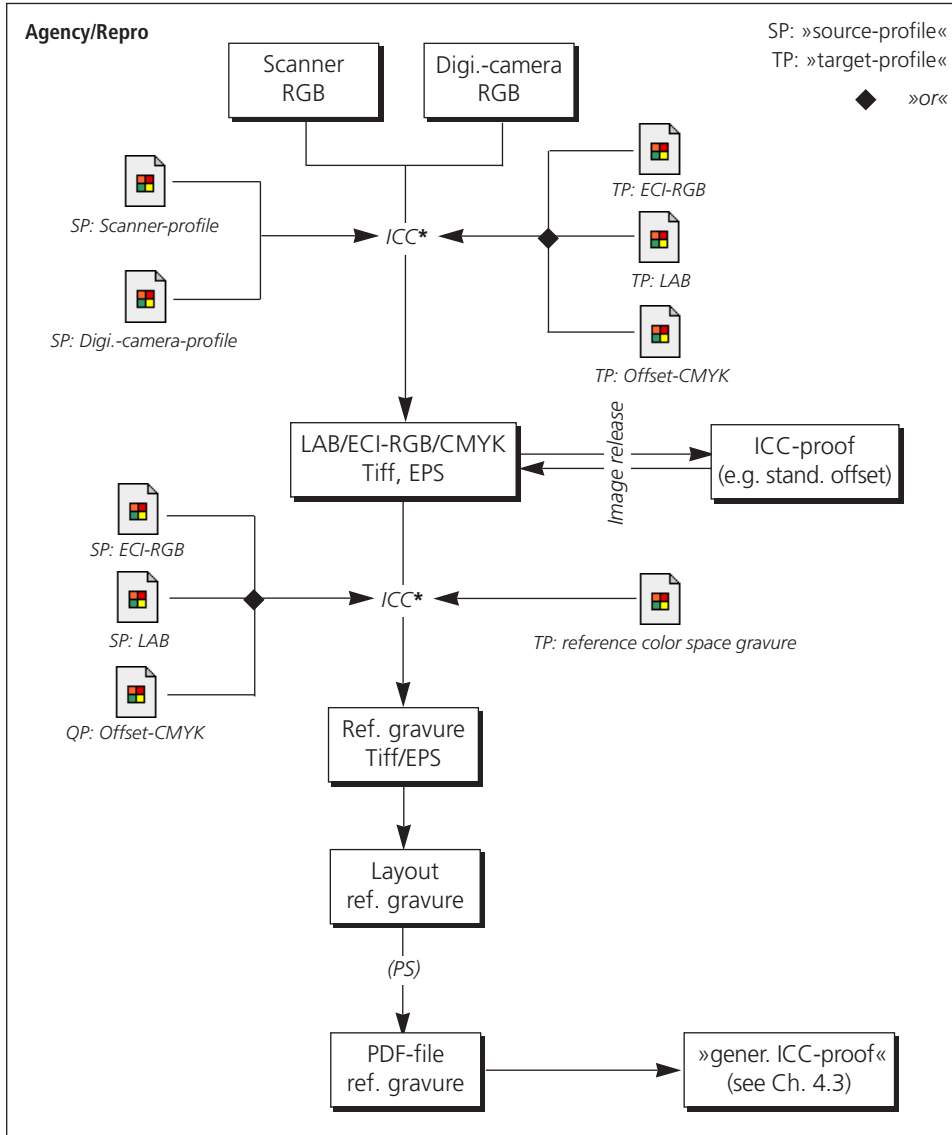

Diagram 5: Print data and proof are produced from print-process-independent data. The proof simulates a process-typical reference-CMYK (e.g. for gravure or offset printing)



*»ICC« indicates a color transformation with ICC-profiles

Diagram 6-1:
Production of PDF-exchange data in reference-CMYK by agency/repro

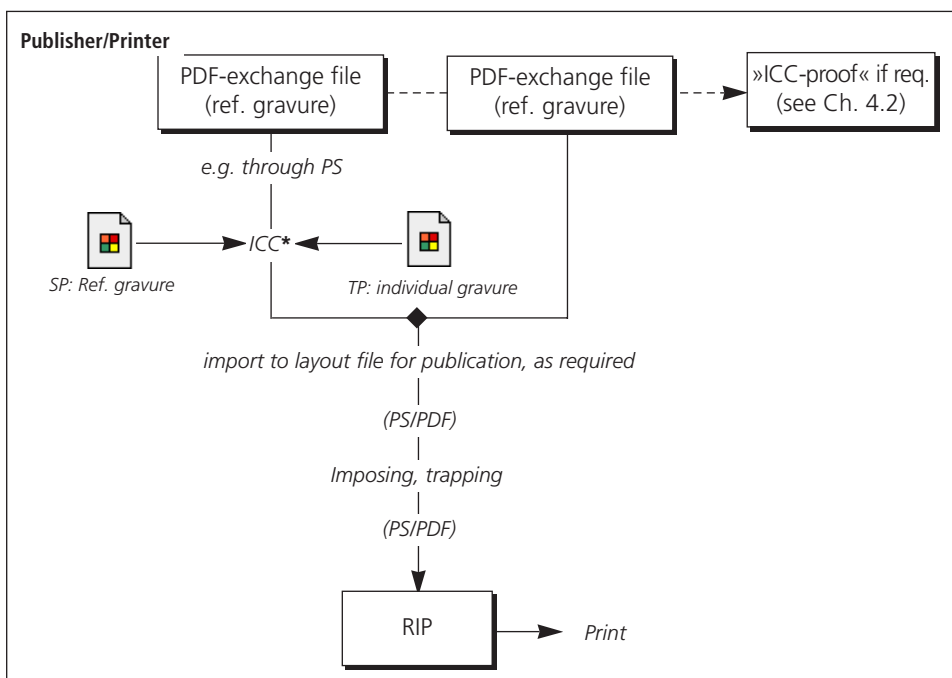

Diagram 6-2:
Editing of PDF-exchange data in reference-CMYK by publisher/printer

Example:

Advertisements are to be reproduced device-independently for numerous publications and passed on to the different publishers for finishing. The image editing is done in Photoshop 5.0 and the advertisement is constructed in QuarkXPress 4.0. Both image editing and layout is done on an Apple Macintosh. ColorSync 3.0 is used with the Apple-CMM as default for all ICC-color transformations. Acrobat Distiller 3.0/4.0 is used for the production of the PDF-file and the color adjustment of the ECI-RGB/LAB-PDF-data is carried out through PostScript with »BatchMaker PS«.

For this the transfer data is produced in the preliminary stage with a defined, print-process-neutral reference-CMYK and is delivered these the appropriate generic CMYK-proof. According to requirement (or if ideally) the basis data is creatively worked and archived in a neutral RGB or CIELAB. The printing house can optionally either directly print the reference-CMYK-data or carry out an ICC-color adjustment according to their individual printing process. This workflow will be described subsequently in further detail, whereby the details explained in the previous section will not be repeated.

The production flow (diagram 6-1) begins with the digitizing of »copies«. The input databases are transformed from the device-specific input-color space to ECI-RGB or CIELAB. It is possible for the original data to be directly converted to a reference-CMYK, but because of the increasing multiple-usage of data it is recommended that the basis data be archived media or print-process neutral.

Creative working is done in ECI-RGB or CIELAB in Photoshop 5.0. The final data can be saved as EPS or TIFF. The evaluation of retouching work and the indication of the image in a printing process can be done in the preview-mode, for example for a reference-CMYK (soft proof). As required, internal proofs can be made from the neutral data.

After the retouching work is complete, the ECI-RGB or CIELAB-data is converted to a reference-CMYK with an ICC-color transformation. Because the different, classical CMYK-printing processes differ in color space and process parameters for the black generation, the process-typical reference-CMYKs should be differentiated between. In gravure printing, for example, a short, narrow black is mostly printed (e.g. total area coverage c. 340-360%, maximum black at 70%, UCR or GCR1), while in rotary or sheet-fed offset a long black from narrow to wide is worked with (e.g. total area coverage c. 320%, maximum black between 85% and 95%, UCR/GCR2). A representative ICC-profile for the gravure area is the »reference color space gravure« and for the offset area the ICC-profile or characterization tables (measured values) from FOGRA, divided for four paper classes.

After converting, any necessary retouchings can be made as well as limited process-specific CMYK-corrections. For the agreement on color and content of the CMYKref-image with the customer or agency, a »generic ICC-proof« is prepared with the appropriate reference-CMYK as the simulation color space. If further corrections are necessary, they are carried out in the image data and proved again.

After the image is released for print then follows the text and image combination in the print-ready final pages in QuarkXPress 4.0. The CMYKref images are imported into the layout and positioned as desired. Special colors and technical tones are laid down as described in the first workflow-variation.

When the print document is ready, the PDF-transfer data can be prepared for the printers. For this, composite-PostScript data with embedded fonts is generated from QuarkXPress with the use of Acrobat-Distiller-PPD. Because CMYK-data can, in principle, be trapped in XPress and this information is lost in the produc-

tion of composite-CMYK-PostScript, it is up to the printing house to trap the data according to the process after accepting the transfer data. There are two reasons that make a composite-CMYK necessary, one because the ideal PDF-workflow requires composite-CMYK, and the other because CMYKref-data can only be ICC-color transformed (if necessary) as a composite-file.

The PDF-file is generated from the PostScript-data with the aid of Acrobat Distiller 4.0. For this the option »Leave Color Unchanged« must be selected in the Distiller's color settings.

For the sake of data control, the »generic CMYK-proof« should preferably be made from the PDF-transfer data. For this, the PDF-data must be converted to PostScript with the Acrobat software. The PS-data, as in the first workflow described, is then proofed with ICC-profiles by means of an ICC-colorserver. Because the image data is already present in the simulation color space (reference-CMYK), it is only necessary to link the source-profile »reference-CMYK« with the target-profile »proofing system« for the ICC-color transformation. The absolute colorimetric rendering intent should be used. The same profile settings as for the image data is used for vector graphics (technical CMYK-tones).

The CMYKref-PDF-documents are written to CD and passed on to the printing house together with the »generic ICC-proofs« (diagram 6-2). The printing house can optionally adjust the reference-CMYK-data again for their individual printing process or print the data in the current CMYKref. For the first instance, the PDF-data must first of all be converted to PostScript with the use of the desired device-PPD and then color adjusted in the ICC-colorserver. The reference-CMYK-profile is used as source-profile for vector and image data and the individual production print-profile as the target-profile. Either the perceptual or relative colorimetric rendering intent should be used for the adjustment. Tests may be necessary to determine which rendering intent is best suited.

From the adjusted PS-data another individual ICC-proof is made to serve as a contract proof for the printer. This is likewise done with the ICC-colorserver. After the color adjustment the PS-data can then go through further editing processes in the printing house. The composite-PS-data now only contain process-adjusted CMYK-data. As a rule they are not changed in the ensuing processes.

In the second instance, the reference-CMYK-data can be passed directly on to print preparation. It is then at the printing house's discretion if a further individual ICC-proof should be made for the printer from the reference-CMYK-data. In the actual printing process the color result is brought up to the reference-CMYK's color space by the ink supply in offset printing or through the control of the gradation curves with the addition of thinner in gravure printing.

A 1.4: Transfer of Process-Adjusted CMYK-Data with Generic or Individual ICC-Proof (Diagrams 8-1 and 8-2)

conceptional:

1. As a rule the agency/repro digitizes copies in the RGB-color space of the input-device and then carries out an ICC-color transformation in LAB or ECI-RGB and saves as needed the device-independent or print process-neutral image-data.
2. Creative retouchings are done either in ECI-RGB or LAB, or in a (company internal) CMYK-standard, for example in the BVD/FOGRA offset standard. In the latter case the LAB or ECI-RGB-data must be color transformed with ICC-profiles to the internal CMYK-working color space.
3. The clearance of the image in color and content is given by the agency or customer on the strength of an »ICC-proof«, for example, in a (company internal) CMYK-standard, e.g. in the offset standard according to BVD/FOGRA.
4. After the image is released for print the LAB, ECI-RGB or CMYK-data is color transformed with ICC-profiles to process-individual composite-CMYKs for the publishing/printing houses.
5. The advertisement is constructed with the adjusted composite-CMYK-data, for example in the layout program QuarkXPress. A number of advertisement-layouts are made as required for the different publishers or publications.
6. Then a PostScript file in adjusted composite-CMYK is made from the advertisement file in its application format.
7. The CMYK-PostScript is converted to a PDF-exchange file in the unchanged CMYK-color space (in accordance with the specifications in Chapter 7).
8. From the PDF-exchange data (preferably directly from the exchange data carrier) the agency/repro produces either »generic ICC-proofs« (according to Chapter 4.3) or process-adjusted »ICC-proofs« (according to Chapter 4.2) for the publishers.
9. The PDF-exchange data is passed on to the publishing/printing house together with the »ICC-proof«.
10. From the PDF-data the publisher produces process-adjusted »ICC-proofs« for the different publications or print processes as an input control of the color data.
11. As necessary the print-adjusted CMYK-data is imported into the layout documents for the different publications. Then follows the print preparation (trapping, imposing, print forme production) and the print.

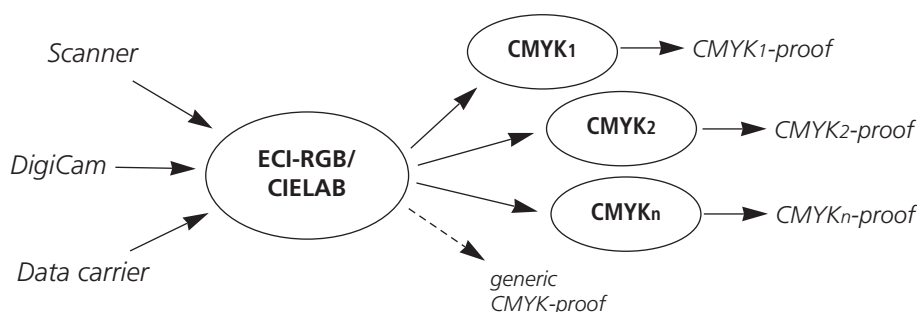
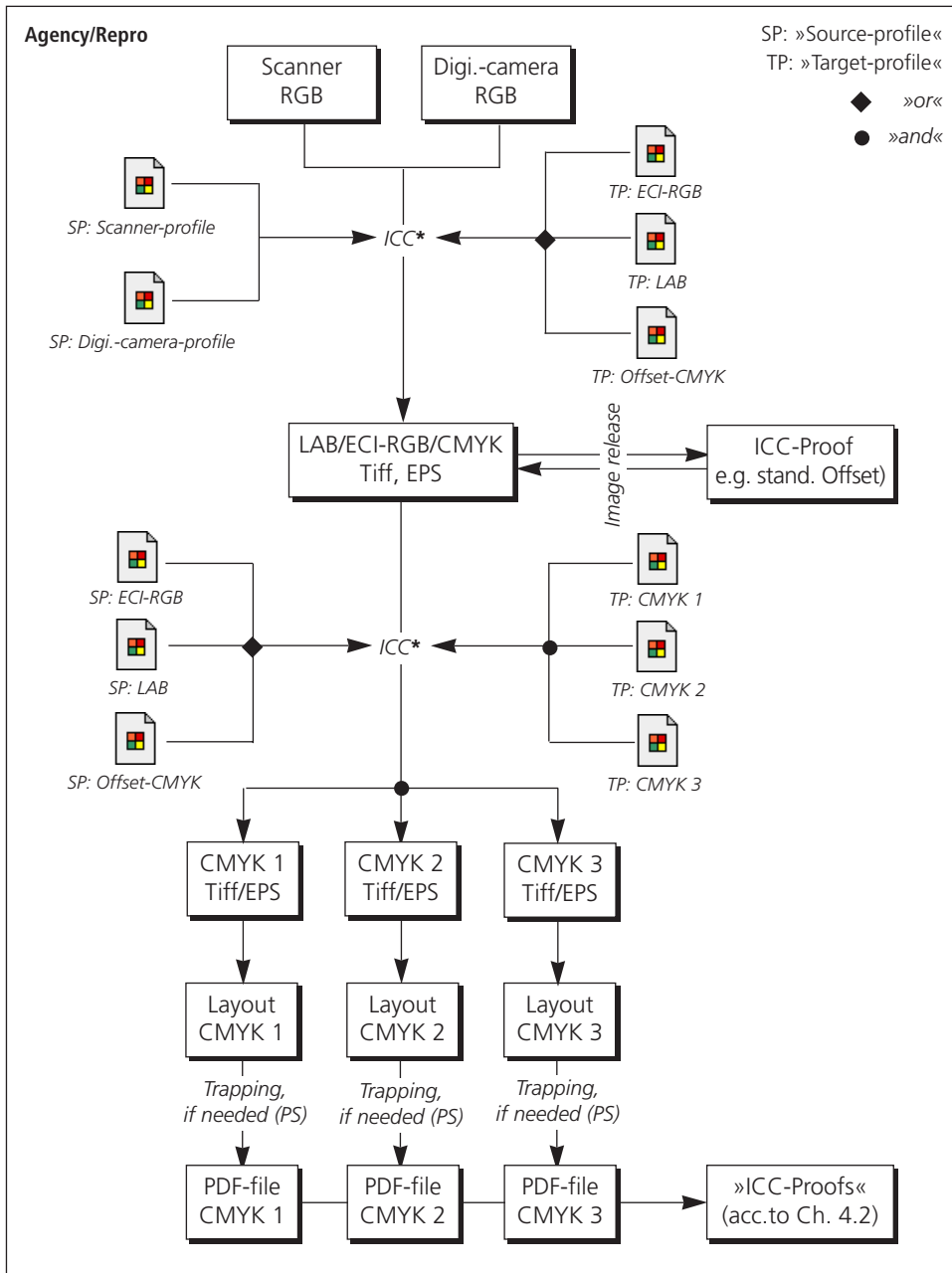

Diagram 7: Individual process-adjusted print data is transferred. The proof simulates the individual production print process or optionally a process-typical reference-CMYK (e.g. for gravure or offset)



*»ICC« indicates a color-transformation with ICC-profiles

Diagram 8-1:
Production of PDF-data in adjusted CMYKs by the agency/repro

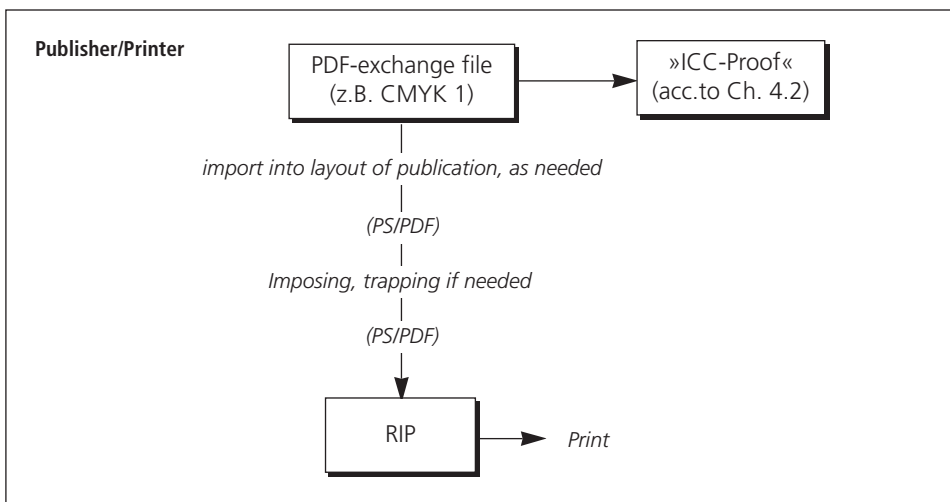

Diagram 8-2:
Editing the adjusted CMYK-PDF-data in the publishing/printing house

Example:

The production flow (diagram 8-1) begins with the digitizing of the »copies«. The input databases are transformed from their device-specific input color spaces to ECI-RGB or CIELAB. It is also possible to transform the original data directly to a reference-CMYK, however, due to increasing multiple usage of data, it is commendable to archive the basis data as device or print process neutral.

Creative editing is done in ECI-RGB or CIELAB in Photoshop 5.0. The final data can be saved as TIFF or EPS. The evaluation of the retouching work and the indication of the image in a printing process can be made in the preview-mode in an internal company standard-CMYK or reference-CMYK (soft proof). If necessary, internal proofs can be made from the neutral data.

After retouching is complete the ECI-RGB or CIELAB-data is converted to the individual CMYK for the data receiver's printing process by means of an ICC-color transformation. This is done as required for every printing house concerned. In practice a gravure printing house works as a rule in its own house printing standard and receive individually adjusted data according to the standard. In the offset area, some large businesses have profiled their printing processes while many medium-sized businesses print »more or less« according to the BVD/FOGRA-offset standard. So in the offset area it needs to be discussed whether the data should be adjusted with individual offset-profiles or whether adjustments according to BVD/FOGRA should be passed on.

Further creative retouching can be made if necessary after the conversion along with process-specific 1-5%-CMYK-corrections. For the agreement on the color and contents of the CMYK-image between the agency and the customer, an »individual ICC-proof« (e.g. gravure, offset) or a »generic ICC-proof« (e.g. offset BVD/FOGRA) is prepared with the appropriate simulation-profile. If the customer desires further corrections to be made then these should be made in the image-data and proofed again.

After the image is released for print then follows the text and image combination as print-ready final pages in QuarkXPress 4.0. The process-adjusted CMYK-data are imported into the layout and positioned as desired. Special colors and technical tones are layed down as described in the first workflow-variation, but in this case in relation to the individual process color space. If necessary then different layout-versions need to be made with the individual CMYK-data for the different printing houses.

When the print document is ready, the PDF-transfer data can be produced for the printing house. First of all, composite-PostScript-data with embedded fonts is generated from QuarkXPress with the use of the Adobe-Distiller-PPD. Because the trapping information in QuarkXPress is lost in the production of composite-CMYK-PostScript, it is the printing house's responsibility to trap the data according to the process.

The PDF-file is generated from the PostScript-data with the aid of Acrobat Distiller 4.0. For this, the option »Leave Color Unchanged« must be deselected in the distiller's color settings.

Individual or generic ICC-proofs are made from the PDF-data. The individual proofs especially, simulate exactly the color result of the edition print from the data receiver. To make the proofs, the PDF-data must be converted to PostScript with the Adobe software. The PS-data is proofed on an ICC-basis with an ICC-color-server. Because the image-data is already present in the simulation color space (individual CMYK), only two profiles need be linked for the ICC-color transformation. The ICC-profile for the printing process is selected as source-profile for the image and outline data and the profile for the proofing system as the target-profile.

If the paper tone of the edition paper needs to be simulated then the »absolute colorimetric« rendering intent should be used. Otherwise the »relative colorimetric« is used. If special colors for an offset job are present in the PS-document, then they too can be simulated as best as possible with ICC-adjustment in the proofer's color space.

The CMYK-PDF-documents are passed on to the printing house together with the individual or generic proofs (diagram 8-2). The printing house, if necessary, converts the PDF-data to PostScript and produces an individual ICC-input proof. If the supplied proof likewise simulates the individual color space then, in an ideal case, the results are identical. The input proof corresponds as well as possible with a supplied generic proof. The proof is made with the use of an ICC-colorserver, whereby the individual process-profile must be linked to the proofer-profile.

The PostScript-data is run through the further editing processes in the printing house (imposing, trapping, forme production). The composite-PS-data only contains process-adjusted CMYK-data, which is subject to no further change whatsoever.

A 1.5: Comparison of Workflow Variations

The described workflow-variations have different properties, advantages and disadvantages. The essentials are noted here in short. In practice, it is above all the last described workflow »Exchange of Process-Adjusted CMYK-Data with Individual ICC-Proof« that is used in advertising production. The first and second workflows are still in the ECI's test phase.

In the first workflow »Exchange of ECI-RGB/LAB-Data with Generic ICC-Proof«, the responsibility for process-specific color adjustment is with the publishing/printing house. The advantage is that the publishing/printing house know best the final requirements (e.g. latest machinery equipment) for the color data.

ECI-RGB has a smaller color-gamut than CIELAB. So the Gamut-Mapping has less influence on the transformation from ECI-RGB to CMYK than CIELAB to CMYK and so a more reliable result in color adjustment can be expected (harmonic gradations, precise color adjustment). The color adjustment for standards of different printing houses will have a better result than currently with CIELAB-data.

With a »generic ICC-proof« the printing house can evaluate the adjustment within known tolerances more clearly than with an »idealized ICC-proof«. Furthermore, the time required in pre-press to produce a generic proof is much less than for process specific proofs and the data can be produced without knowledge of the final printing process (e.g. machine x).

A disadvantage of this print-process-neutral workflow is that there is no correction stage for required adjustments to the process-adjusted database. The transfer of neutral data requires that they can be adjusted with ICC-profiles in the printing house for optimal results without additional corrections.

In the second workflow »Transfer of Reference-CMYK-Data with Generic ICC-Proof«, the responsibility for the process-specific adjustment (either with an ICC-transformation or color control) lies also with the printing house. Because of the similarities in color range between the reference-CMYKs and the individual process color spaces, the influences of Gamut-Mapping are slight and reliable color adjustment results can be achieved. However, the black generation and total inking of the source data can change considerably in a CMYK-to-CMYK color transformation. For this reason, significant differences in the process parameters of the reference-CMYK and the individual color space should be avoided. Furthermore, the different individual adjustments are unified in the printing house and can be clearly evaluated on the strength of the generic CMYK-proof, and within tighter limits by the printing house. The responsibility for the adjustment is therefore carried by the printing house.

Furthermore, process-typical color corrections are possible to an extent in the editing of reference-CMYK-data (CMYK-based corrections). The optional ICC-adjustment carried out by the printing house must not necessarily be re-edited. It should be mentioned again that this only applies when the black generation does not change much through the ICC-transformation.

Furthermore, the time taken in pre-press is reduced with the production of generic rather than process-individual proofs and the data can be produced without prior knowledge of the final printing process (e.g. machine x).

A disadvantage to this workflow is the reference-CMYK-data is print process-dependent and reduced in color information. An additional saving of the original, media-neutral data (ECI-RGB, LAB) is recommendable, but requires more time for archiving.

In the third workflow the responsibility for the process-specific color adjustment lies with the pre-press service. They retain the profiles from the printing houses, carry out the color adjustment, correct the color data and come to an agreement with the customer or agency. They thereby control the identity of the adjustment for different printing houses. The printing houses receive, along with the individual data and CMYK proofs, an unambiguous contract proof, based on which the print result should be produced.

The advantages are that the agency, who knows the customer's wishes best, can communicate these to the repro service and adapt them to the process-specific color space. So, the creative and process-specific corrective step in the adjusted data lays on the side of pre-press, where the data is still accessible in open files and where the reprotechnical know-how is available.

However, this workflow does have disadvantages, which above all lay in the time taken for production by the pre-press service. Firstly, the extra route through media-neutral image digitizing and image archiving is necessary for multiple data usage. Furthermore the agency / repro must produce individual process-adjusted image-data for each data receiver as well as layouts and finally also proofs.

Apart from that, the printing processes must be communicated in the form of ICC-profile exchange and publishing/printing houses are less flexible in the use of adjusted data. They are responsible for a high degree of reliability in process-specific reproduction.

The following chart summarizes the advantages and disadvantages:

<i>Workflow-Variation</i> <i>Workflow-Aspect</i>	ECI-RGB-/LAB-Data and generic proof	Reference-CMYK-Data and generic proof	individaul CMYK-Data + gener. or ind. proof
Responsibility for process-individual color adjustment	<i>printing house</i>	<i>repro/printing house</i>	<i>repro</i>
Time needed for reproduction in pre-press	<i>slight</i>	<i>medium</i>	<i>high</i>
Time needed for proof in pre-press	<i>slight</i>	<i>slight</i>	<i>high</i>
Process-specific reproduction reliability	<i>medium to slight</i>	<i>medium</i>	<i>high</i>



European Color Initiative
www.eci.org

APPENDIX 5

»Process Control –The Ugra/FOGRA Media Wedge–

Contents

- A 5.1: Process Control in ICC-Workflows
- A 5.2: The Ugra/FOGRA CMYK-Media Wedge
- A 5.3: The Ugra/FOGRA CIELAB-Media Wedge

A 5.1: Process Control in ICC-Workflows

The ICC-based reproduction technology requires a universal process control strategy. Color-stable input and output systems and a (at least company internal) standardization of pre-press and printing processes, as in the classical reproduction environment, are basic requirements for the mastery of color editing processes. Alongside the color-influencing process parameters, which result from the variations in hardware or partial production stages and printing processes, further variable parameters are added to an ICC-workflow, which are to be found in the actual ICC-technology. CMMs (Color Management Modules) from different manufacturers, for example, produce different results in color transformation because of non-uniform interpolation mechanisms. Further variable parameters are the ICC-color profiles themselves. There is no established, standard method in the ICC-specification for calculating the separations parameter and Gamut-Mapping-Strategy used in profile generation. Different manufacturers of profile generating software use different methods for calculating the black generation (with the same parameter-settings defined by the user) as well as for the Gamut-Mapping. ICC-color profiles, which have been generated with different profile generating software with the same measurement data and under formally equal conditions, can possibly produce different results in color transformation. This is particular true of transformations with the »perceptual« rendering intent, which as a rule is used for process-individual adjustments (or separation) of color data for edition printing. Because the Gamut-Mapping-Strategy forms a mark of quality and a means of competition for the different manufacturers of profile generating software, significantly different results in a mixed workflow should be reckoned with.

Altogether, the system components and partial processes in an ICC-workflow should therefore be monitored and stabilized, and the ICC-color transformations checked, with a suitable means of control (for example with the analogue/digital process control system from FOGRA). The Gamut-Mapping-Process used should be characterized in the control process.

The rule generally applies that all peripheral devices must run stably and all partial processes must be carried out under standardized conditions before they can be profiled. If digital color printing systems, for example, are first of all calibrated and then profiled, then should fluctuations in the color reproduction occur, a re-calibration of the system is usually sufficient and the ICC-color profile is again correct. The Federal Association of Printers (BVD) in Wiesbaden defined in 1997 with the »MediaStandard Print« measures for process control which can be implemented in the ICC-work environment (see Appendix 6).

Within the framework of these ECI-Guidelines the integration of one of the Ugra/FOGRA media wedges (CMYK-media wedge, CIELAB-media wedge: in preparation) is established for the examination of exchange color data and exchange proofs. This chapter describes the concept and the construction as well as the implementation and use of both media wedges in the ICC-workflows as defined by the ECI (general information on the media wedges can be found in the appropriate users handbook from FOGRA).

A 5.2: The Ugra/FOGRA CMYK-Media Wedge

The Ugra/FOGRA CMYK-media wedge serves, above all, as the visual and measurable comparison-control of the proof and edition print as well as the control of nominal densities and tonal changes of the process colors in the edition print. Furthermore, it is used in practice for the control of (ICC-) color transformations in the proof. Alongside these main areas of use, further instances in the CMYK-workflow for color reproduction can be controlled which are not listed here (detailed information can be found in the users handbook for the media wedge).

Characteristic of the process control in modern reproduction technology is that all input and output processes involved in an (ICC-) workflow are evaluated colorimetrically (with ICC-devices and partial process profiles). New printing standards (e.g. ISO 12647/1-3) no longer establish the target color values and tolerances as CMYK-percent area coverage but as CIELAB or Delta-E-values. Because the printing area is, as before, printed with the process colors **cyan**, **magenta**, **yellow** and **black** and the control of the CMYK-orientated print reproduction and partial processes, FOGRA has conceived with the CMYK-media wedge a means of control which allows for an examination of the area coverage of the pure primary colors as well as the mixed colors in print and for other controls of the (ICC-) color adjustment for the proof. However, these functions can only be limitedly unified within a narrow CMYK-control element. The following explains how to implement the CMYK-media wedge and how to evaluate the »results«.

The CMYK-media wedge is first of all conceived for offset printing in accordance with ISO 12647-2 (FOGRA/BVD offset standard). The color fields in the wedge form a selected subset of the color fields contained in the IT8.7-3-output test chart (according to the color chart ISO 12642). The wedge covers the pure process colors C, M, Y in the percent area coverages of 100%, 70% and 40% and the secondary colors R, G, B (R: M+Y, G: C+Y, B: M+Y) in the percent area coverages of 100%, 70% and 40% (sum of total area coverage for R, G, and B 200%, 140%, 80% respectively), as well as further mixed colors (tertiary colors) and a white field (paper white). Furthermore, the wedge covers two greytone scales. The top scale is made up of the process color black and the bottom scale of certain combinations of CMY-values which, depending on printing process, can produce a more or less neutral grey tone (detailed information on the construction of the wedge and a chart with the CMYK-area coverages can be found in the appropriate users handbook from FOGRA).

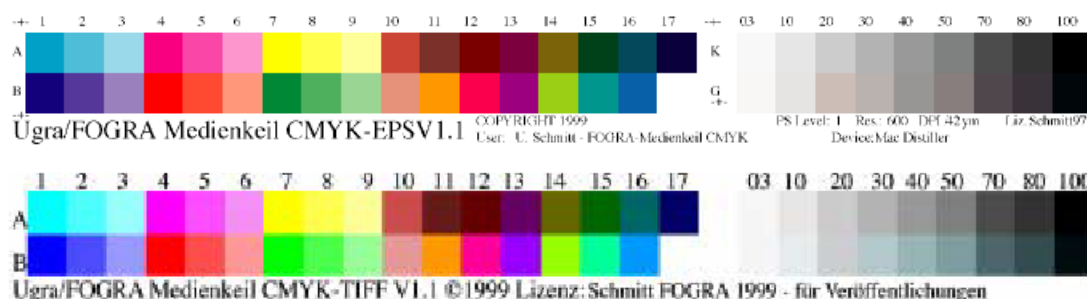

Diagram 1: CMYK-media wedge, above: EPS, below: TIFF

CIELAB-measured values, in accordance with the BVD/FOGRA offset standard, for different paper classes are supplied for the color fields and the achromatically constructed greytone scales in the CMYK-wedge (an overview of the CIELAB-nominal values for the three paper classes can be found in the appropriate users handbook from FOGRA). In an ideal case the colorimetric measured values of the proofed and printed CMYK-wedge would then correspond with the BVD/FOGRA CIELAB-measured values. If the wedge is to be used in other CMYK-printing processes (e.g. gravure) then individual CIELAB-measured values (nominal values) can be produced by print proofing the wedge under stable printing conditions measuring them colorimetrically.

Generally the CMYK-media wedge should be passed through the entire editing process along with the CMYK-color data and thereby run through all color-altering editing stages and process parameters. In an ICC-workflow, the wedge must be color transformed as necessary. The CMYK-wedge is available in the data formats TIFF and EPS. Both variations are made up of the same color fields. The EPS-wedge can additionally call up certain status information during the output process such as the PostScript version of the RIP, device resolution etc. The CMYK-wedges can be loaded into all application programs with an EPS or TIFF import function (detailed information in the handbook to the CMYK-media wedge). EPS is generally the mightier data format because it can contain linework-data (vector and curve information) as well as pixel-data. If the application program supports the import of EPS-data then the EPS-wedge should be used. Otherwise the pixel-orientated TIFF-wedge.

Within the framework of the ECI-Guidelines, the CMYK-media wedge from Ugra/FOGRA should be carried over in the following areas:

- in the exchange of PDF-files in the CMYK-color space (in accordance with the specifications in Chapter 7-x.)
- in the production of the proof of the CMYK-transfer data (»ICC-Proofs« in accordance with Chapter 4.2).

The CMYK-wedge should, for example, be imported into the print data in the layout phase without any prior ICC-color transformation and outside of the net format. A PostScript-file and then a PDF-file is produced from the finished layout file with the process-adjusted CMYK-images and the CMYK-media wedge. An ICC-proof is then made from the PDF-file. When the composite-CMYK-data is transferred, a process-individual »ICC-proof« is made in accordance with the specifications in Chapter 4.2 and passed on together with the PDF-data to the data receiver. Because the »ICC-proofs« are made from the print ready PDF-transfer data, the CMYK-wedge is inevitably output and runs through the arising ICC-color transformations. When the data receiver outputs the composite-CMYK-data adjusted for his edition print, the CMYK-data, as a rule, undergoes no further color transformation but is broken down into the individual color separations and then printed.

In the ICC-color transformation for the proof, the defined CMYK-values of the media wedge are first of all transformed with the allocated production print-profile (source-profile: e.g. offset-profile according to BVD/FOGRA) to LAB (Profile Connection Space) and then with the target-profile to the proofer's CMYK-color space. For this, the »absolute colorimetric« rendering intent (with paper white simulation) or »relative colorimetric« (without paper white simulation) should be used. The result of the ICC-color transformation is that the pure process colors C, M, Y and K are no longer made up of just themselves but contain small proportions of the other process colors (diagram 2). The same is true of the mixed colors R, G, and B and the tertiary colors. This effect is desired because the proofing system should simulate the colors of the production print as well as possible with its own. If the wedge is then colorimetrically measured with a spectrophoto-

meter then, in an ideal case, the CIELAB-values of the wedge on the proof are identical to those of the edition print, for example those of the enclosed CIELAB-chart from FOGRA for offset printing. However, this is only true of the chromatic color fields and the achromatic greytone scale.

An exceptional feature is the color grey-scale wedge. This is laid down in certain CMY-percentual area coverages and therefore is defined device-dependently. Every printing process has an individual grey balance. The wedge is specially tailored for the offset standard so that the CMY-constructed grey tone scale can reproduce a neutral grey as closely as possible under standardized printing conditions, but each of the three considered paper classes requires in principle slightly different definitions for a chromatic grey. So the bottom greytone scale, in most cases, will not be depicted as a neutral grey in the proof print. However, the greytone scales in the proof and print are comparable. If the ICC-production print profile represents the print precisely then the grey axis in the CMYK-wedge in the proof print will be as slightly shifted as later in print. In this way the validity of the production print profile can be judged. Because the actual CMYK-image data to be proofed is present in the process-individual CMYK-color space (ideally color adjusted with the profile which is used as source-profile in the proof) one cannot assume that the grey axis in the image data is as shifted as the axis depicted in the CMYK-media wedge.

The CMYK-media wedge undergoes no further color transformations for the edition print. In print the wedge is subject to the printing process-specific reproduction characteristics and will be depicted, altered in its colors. These changes to the wedge are simulated in the proofing process with the appropriate production print profile. Therefore the wedge in the proof and in print is comparable and, in an ideal case, should produce the same CIELAB-measured values. In direct comparison this also applies for the chromatic grey axis. Because the CMYK-wedge in the definition of the percent area coverages is not altered by further color transformations, the printing process will reproduce pure, unmixed process colors which allow for a classical control of the full-tone densities and dot gains with a densitometer or spectrophotometer (diagram 2). If printing is done for example according to the offset standard of BVD/FOGRA, the full-tone densities and dot gains can be appropriately evaluated colorimetrically in CIELAB and Delta-E-values in accordance with the printing standard ISO 12647-2. Also in this case of edition printing the grey tone scale reproduced in the CMYK-wedge, due to its device-dependent definition, cannot be judged for its absolute correct depiction, but only in comparison to the proof. Print and proof reproduce the scale just as well or just as badly as each other.

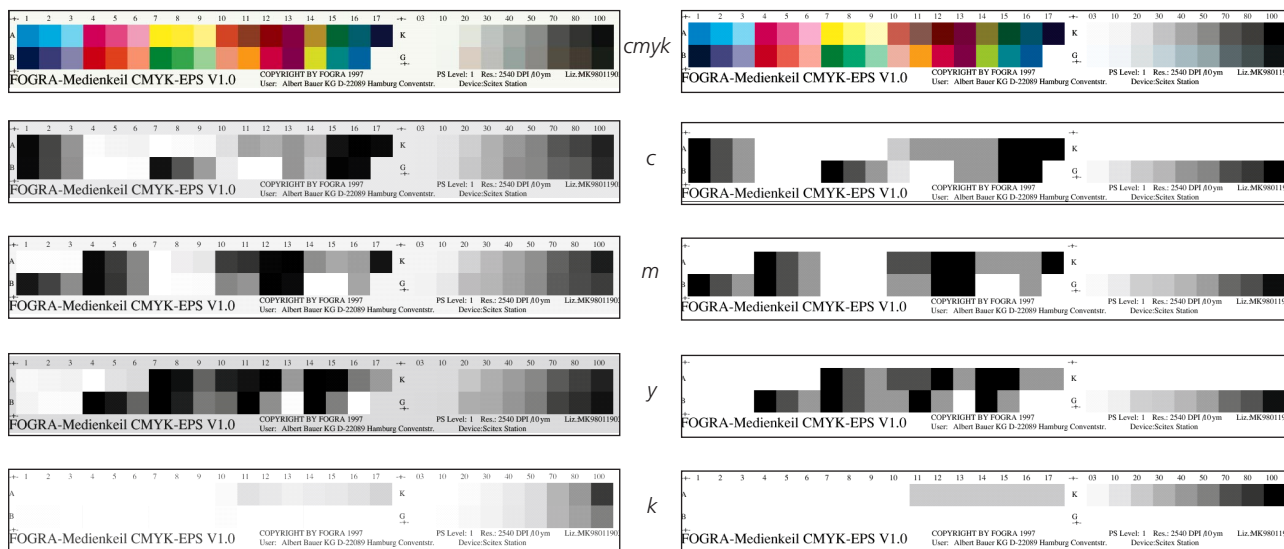

Diagram 2: Depiction of the individual color channels of the Ugra/FOGRA CMYK-media wedge, left: after the ICC-transformation for the proof, right: untransformed for the print.

On the whole, the following criteria in an ICC-CMYK-workflow with a CMYK-media wedge can be visually evaluated and controlled by measuring:

- Inspection of the quality of the ICC production print proof or the ICC-color transformation for the proof. If the color fields as well as the achromatic and color grey axes of the CMYK-wedge are reproduced the same in color in the proof and edition print, then the profile for the edition print is still valid.
- A visual comparison and one with color measurements of the ICC-contract proof with the edition print. If printing has been done in accordance with ISO 12647-2 then the measurement comparison can be done with the supplied CIELAB-nominal values from FOGRA. For applications in other printing processes, individual CIELAB-nominal values can be produced on the strength of the proof-printed CMYK-wedge.
- Colorimetric and densitometric inspection of the full-tone densities and dot gains in the edition print.

The following conclusions should by no means be drawn from the results of the proofed and printed CMYK-media wedge:

- Absolute evaluation of the CMY-constructed greytone scale in the CMYK-media wedge. The greytone scale is defined device-dependently and in most printing processes cannot be reproduced as neutral grey. For this reason the CIELAB-charts from FOGRA do not contain CIELAB-nominal values for the fields of the CMY-constructed greytone scale. However, a relative comparison between proof and print is possible.
- Conclusion from the fluctuations in the reproduced CMY-greytone scale on the image's contents. Because the CMYK-image data is already adjusted to the individual printing process, the CMY-greytone scale in the wedge is not representative of the grey balance in the image data.

The CMYK-wedge is a means of control with which, on one hand, the ICC-color transformation for the proof (relative to the print) can be controlled and, on the other, the full-tone densities and dot gains of the process colors in the print with the same comparison parameters – CIELAB-nominal values. In the case of the proof, the edition print colors must be simulated by a mix of the proofing system's own CMYK-colors, in the

edition print, pure, single-color constructed CMYK-color fields are required for the evaluation. So that this works, the means of control must be defined in CMYK. However, CMYK-definitions are generally not device-neutral, so an absolute control as well as a direct conclusion on the reproduction of image from the depiction of the control element is not possible here. Above all, this is true of the CMY-constructed greytone scale in the CMYK-media wedge.

A 5.3: The Ugra/FOGRA CIELAB-Media Wedge

The CMYK-media wedge is only suitable for the use in CMYK-orientated editing processes. In a consistent CMYK-based workflow, the wedge can run through with data from the input phase through finishing to output. In modern ICC-reproduction technology, image data is digitized and prepared first of all device-independently. First at the end of the reproduction chain is the neutral data adjusted for a specific output process. Within this production chain, the color data runs through many ICC-color transformations as well as program-internal color conversions such as in Adobe Photoshop. The CMYK-wedge, in these workflows, can only be used for the print-specific partial finishing stages at the end of the production chain. In order to also be able to monitor the media-neutral color editing stages, a means of control is required that is defined device-neutrally. The Ugra/FOGRA is preparing a media wedge which can be laid down in the device-independent CIELAB-color space. The Ugra/FOGRA CIELAB-media wedge should allow for a visual evaluation and one with measurements of any ICC-transformations. In an ICC-workflow with the aim of process-specific CMYK-output, the CIELAB and CMYK-media wedges can supplement each other.

An ICC-color transformation is not so extensively standardized that it can produce identical color results in ICC-working environments under formally the same conditions (see also Chapter 5, Introduction). The different ways of working of CMMs from different manufacturers, as well as Gamut-Mapping and black generation solutions in the ICC-color profiles lead to different color adjustment results. With the CIELAB-wedge it can be checked how certain color areas change with an ICC-color transformation. A direct conclusion from the results of the CIELAB-wedge on the image data is possible because the wedge is always transformed from the same color space to the same target-color space as the actual image data. The evaluation can always be made in the workflow when color transformation results are visualized, e.g. on a hardcopy proof, soft proof or in print.

The CIELAB-media wedge consists of three rows of color fields which represent certain areas of the CIELAB-color space. Three »color rings« with different intensities of saturation ($C = \text{Chroma}$) and the same lightness ($L = 50$) form the wedge. In each coloring, the full color circle (360°) is represented by 16 steps with an angle of $\Delta h = 22.5^\circ$ (diagram 3).

The row »I« contains colors from the outmost ring, colors with maximum saturation ($C = 100$). These describe the limits of the »Ideal« color space and are no longer depictable in practically any CMYK-printing system, they are therefore compressed in an ICC-transformation. The row »R« contains colors from the color ring of saturation $C =$ (still to be calculated). These describe the limits of a »Real« color space and are depictable in many, but not all, CMYK-printing processes. These colors are sometimes slightly compressed. The row »M« contains colors from the color ring saturation $C =$ (still to be calculated). These describe the limits of a »Minimal« color space and are depictable in practically all CMYK-reproduction systems (e.g. newspaper printing). These colors, in most cases, need not be compressed. Furthermore, the wedge contains a grey axis defined in

LAB-values (M19 - M25: L = 10 - 70). All reference LAB-values for the CIELAB-wedge are summarized in an ASCII-chart.

On the strength of the three color ranges, it can be colorimetrically inspected what happens to LAB-values in the ICC-process chain. The LAB-values for the row »I« will show in print the greatest Delta-E-deviations to the reference values. The deviations in the row »R« will be less and the values in the row »M«, in an ideal case, are identical to the the reference values.

The Ugra/FOGRA CIELAB-media wedge is available in the data formats TIFF and EPS. Both variations consist of the same color fields. The EPS-wedge, in a PostScript-based working environment, can call up certain additional information during the output process, for example the PostScript-version of the RIP, the device resolution etc. The CIELAB-wedges can be loaded into any application program with EPS or TIFF import functions.

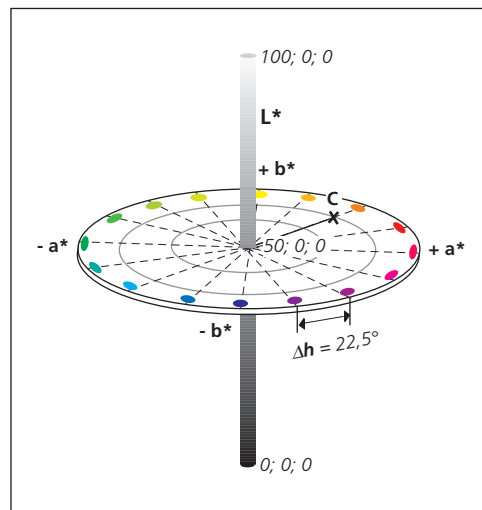

Diagram 3: the CIEL*a*b*-color space

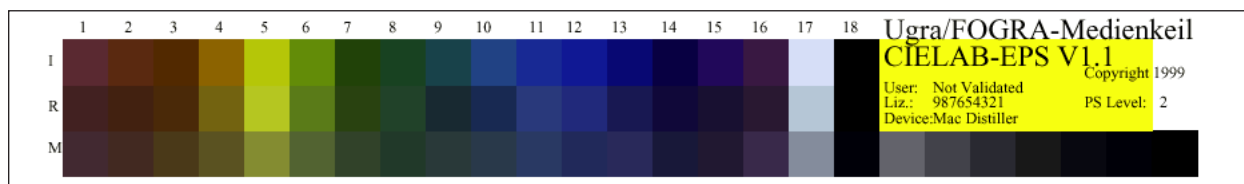

Diagram 4: the Ugra/FOGRA CIELAB-media wedge

Within the framework of the ECI-Guidelines, the Ugra/FOGRA CIELAB-media wedge should be run through the following areas together with the data:

- when transferring PDF-files in the CIELAB or RGB-color space in accordance with the specifications in Chapter 7-x.
- when producing a proof from the CIELAB or RGB-transfer data (»idealized ICC proofs« in accordance with Chapter 4.1 and »ICC proofs with generic profiles« in accordance with Chapter 4.3).

The rule, generally, is that the integrated media wedge in the PDF-transfer data must be present in the identical color space as the color data. When producing PDF-files in the CIELAB-color space (CIELAB D50) the CIELAB-wedge in the layout phase, for example, should be imported without any previous ICC-color transformation into the print file outside of the net format. After that, a PostScript is produced and from that a PDF-file. An ICC-proof is made from the CIELAB-PDF-file. As a rule, when transferring CIELAB-data, an »ICC-proof with generic profiles« is made in accordance with the specifications in Chapter 4.3 and passed on to the data receiver together with the PDF-data. Because the »ICC-proofs« should be made from the completed PDF-transfer file, the CIELAB-wedge is inevitably output and runs through the necessary ICC-color transformation for the proof. When the data receiver adjusts the CIELAB-data with the appropriate ICC-profile for his edition print, then the CIELAB-wedge is transformed with the same profile.

When producing PDF-files in the ECI-RGB color space in accordance with the specifications in Chapter 7, the Ugra/FOGRA CIELAB-media wedge (TIFF) should first of all be color transformed to ECI-RGB. For this, a CIELAB(D50)-profile must be used as the source-profile and the ECI-RGB-profile as the target profile. After this,

the processing of the »transformed CIELAB-wedge« (»ECI-RGB-wedge«) does not differ, in principle, to the procedures described in the previous section.

In an ICC-color transformation, the rendering intent, among others, controls the color adjustment to a great extent. The ICC-standard has established four different color adjustment methods (the meaning of the four rendering intents »perceptual«, »relative colorimetric«, »absolute colorimetric« and »saturation« can be read in Appendix 6). Only the objectives of the color adjustment are described and not the specific process. Consequently, the different manufacturers of profile-generating software use different Gamut-Mapping-Strategies for the conversion of rendering intents. »Perceptual«, especially, is very much manufacturer-dependent. »Perceptual« should reproduce the source color space of an image in the target color space of the output medium so that the human eye perceives it as true to the original.

»Perceptual«, as a rule, is used for the color transformation of (device-neutral) color data in the process-individual CMYK-color space (separation). Put simply, a non-linear color space adjustment hereby occurs between the source color system and the target color system. Color areas in the source system which lay far outside the target system are pushed strongly »in the direction of the target color space«, areas at the edge of the target system are not influenced as strongly and areas already within the target color space only slightly. Because the criterion for the »perception-orientated« color adjustment leaves a lot of room for interpretation, such as which color area is projected where, the manufacturer's Gamut-Mapping-Strategies, to an extent, differ greatly from one another. Particular large differences can be seen in the depiction of colors which lay far outside the target color space (Out-of-Gamut-Mapping) and in the handling of neutral colors near the grey axis. The criterion for the colorimetric best possible color transformation with as small a Delta-E-deviation as possible is clear, so the Gamut-Mapping-Strategies for the »absolute colorimetric« and »relative colorimetric« rendering intents do not differ to greatly.

In the transformation of the CIELAB-media wedge, the Gamut-Mapping-influences can be documented for every ICC-transformation stage. In the adjustment of the CIELAB-wedge to a CMYK-color space with the »perceptual« rendering intent, the color fields in the row »I« are subject to very strong Gamut-Mapping-influences, those in row »R« not so strong and the color fields in the row »M« only slight. With the use of ICC-profiles based on the same measuring data, but generated with different profile-generating products, one will see that the transformation results particularly in the color fields far outside the target color space differ very much from each other.

In the transformation of the CIELAB-wedge to a specific CMYK, the CIELAB definitions of the color fields are ordered in CMYK-combinations, which depict as well as possible the the CIELAB-values with consideration of the target depiction (determined by the rendering intent used). Because the ICC-production print profile contains a print process-specific black generation, the grey axis in the media wedge, with a good ICC-profile, is also made up of a CMY(K)-combination, ideal for the printing process.

The following criteria can be controlled with the CIELAB-media wedge:

- Evaluation of each individual ICC-color transformation with direct conclusion of the image reproduction. If, for example, the grey axis in the CIELAB-media wedge is not consistently neutral grey, then the grey axis in the image will be equally shifted. The evaluation can be made in every phase of visualization (on the monitor, in the proof, in print) with measuring technology and visually.
- Absolute control of the grey axis after every ICC-color transformation. As opposed to the CMYK-wedge which only allows for a relative comparison of the grey axis in proof and print, the grey axis in the CIELAB-media wedge should, with a good profile, be ideally reproduced neutral grey.
- Visual and measured comparisons of the proof with the edition print. The CIELAB-wedge, transformed to the process-individual CMYK, does not produce pure color fields for the individual process colors. But in an ideal case the color rendition of the CIELAB-wedge corresponds between proof and print. Furthermore, the CMY-constructed grey axis is ideally reproduced as neutral grey in both cases.

The Ugra/FOGRA CIELAB-media wedge is a means of control for checking (ICC)-color transformations and the appropriate ICC-profiles or transformation charts. Because it is device-independently defined in the CIELAB-color space, it can accompany the color data through the whole process chain with all its transformations. The CIELAB-media wedge is not suitable for control in the classical printing process (full-tone densities, dot gains, etc.). For this, the CMYK-media wedge, for example, can be used (Diagram 5).

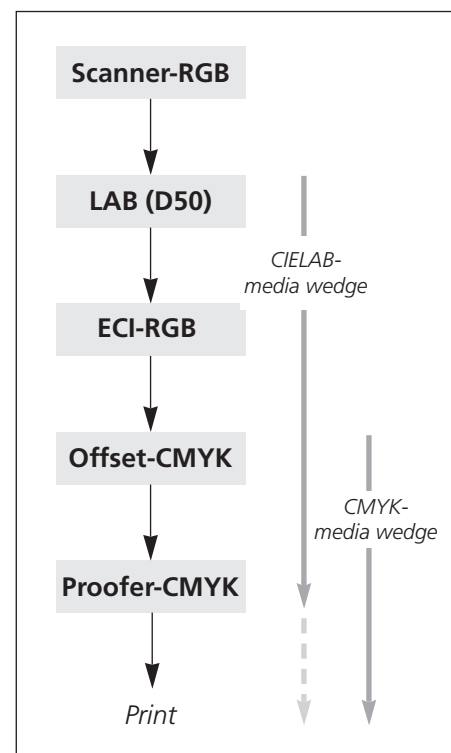

Diagram 5: Example of an ICC-color transformation chain and the use of the Ugra/FOGRA media wedge.